

Electromagnetism for Electronic Engineers

Richard Carter

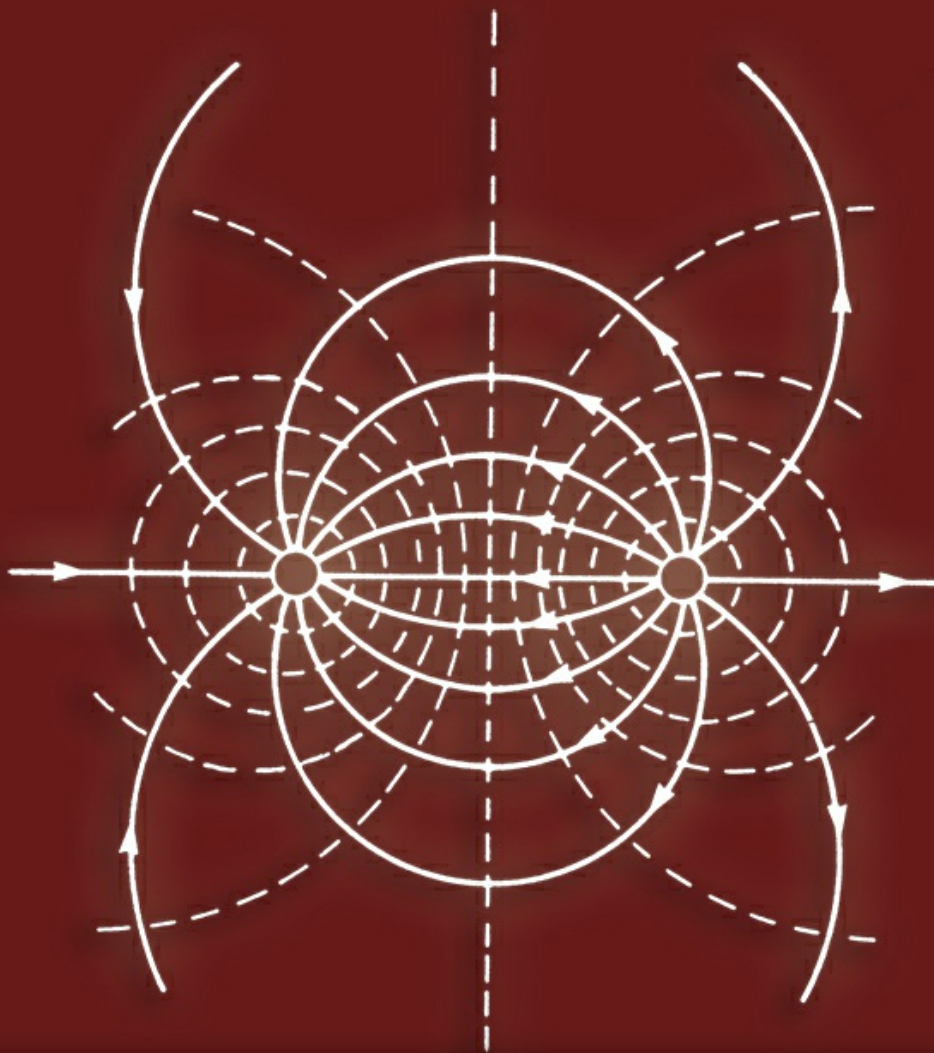

Download free books at

Richard G. Carter

Electromagnetism for Electronic Engineers

Electromagnetism for Electronic Engineers

1st edition

© 2010 Richard G. Carter & bookboon.com

ISBN 978-87-7681-465-6

Contents

	Preface	10
1	Electrostatics in free space	12
1.1	The inverse square law of force between two electric charges	12
1.2	The electric field	13
1.3	Gauss' theorem	16
1.4	The differential form of Gauss' theorem	18
1.5	Electrostatic potential	20
1.6	Calculation of potential in simple cases	22
1.7	Calculation of the electric field from the potential	23
1.8	Conducting materials in electrostatic fields	26
1.9	The method of images	28
1.10	Laplace's and Poisson's equations	29
1.11	The finite difference method	31
1.12	Summary	33

**YOU THINK.
YOU CAN WORK
AT RMB**

**RAND
MERCHANT
BANK**
A Division of FirstRand Bank Limited
Traditional values. Innovative ideas.

Rand Merchant Bank uses good business to create a better world, which is one of the reasons that the country's top talent chooses to work at RMB. For more information visit us at www.rmb.co.za

Thinking that can change your world

Rand Merchant Bank is an Authorised Financial Services Provider



Click on the ad to read more

2	Dielectric materials and capacitance	34
2.1	Insulating materials in electric fields	34
2.2	Solution of problems involving dielectric materials	37
2.3	Boundary conditions	39
2.4	Capacitance	41
2.5	Electrostatic screening	41
2.6	Calculation of capacitance	44
2.7	Energy storage in the electric field	46
2.8	Calculation of capacitance by energy methods	47
2.9	Finite element method	48
2.10	Boundary element method	49
2.11	Summary	50
3	Steady electric currents	51
3.1	Conduction of electricity	51
3.2	Ohmic heating	53
3.3	The distribution of current density in conductors	55
3.4	Electric fields in the presence of currents	57
3.5	Electromotive force	58
3.6	Calculation of resistance	59



Discover the truth at www.deloitte.ca/careers

Deloitte.

© Deloitte & Touche LLP and affiliated entities.



Click on the ad to read more

3.7	Calculation of resistance by energy methods	61
3.8	Summary	61
4	The magnetic effects of electric currents	62
4.1	The law of force between two moving charges	63
4.2	Magnetic flux density	64
4.3	The magnetic circuit law	67
4.4	Magnetic scalar potential	69
4.5	Forces on current-carrying conductors	70
4.6	Summary	71
5	The magnetic effects of iron	72
5.1	Introduction	73
5.2	Ferromagnetic materials	73
5.3	Boundary conditions	77
5.4	Flux conduction and magnetic screening	77
5.5	Magnetic circuits	80
5.6	Fringing and leakage	82
5.7	Hysteresis	84
5.8	Solution of problems in which μ cannot be regarded as constant	87

**I WANT TO CHANGE DIRECTION,
AND THE WORLD.**

GOT-THE-ENERGY-TO-LEAD.COM

We believe that energy suppliers should be renewable, too. We are therefore looking for enthusiastic new colleagues with plenty of ideas who want to join RWE in changing the world. Visit us online to find out what we are offering and how we are working together to ensure the energy of the future.

RWE
The energy to lead



5.9	Permanent magnets	89
5.10	Using permanent magnets efficiently	90
5.11	Summary	92
6	Electromagnetic induction	93
6.1	Introduction	93
6.2	The current induced in a conductor moving through a steady magnetic field	94
6.3	The current induced in a loop of wire moving through a non-uniform magnetic field	96
6.4	Faraday's law of electromagnetic induction	97
6.5	Inductance	100
6.6	Electromagnetic interference	102
6.7	Calculation of inductance	105
6.8	Energy storage in the magnetic field	108
6.9	Calculation of inductance by energy methods	110
6.10	The LCRZ analogy	111
6.11	Energy storage in iron	113
6.12	Hysteresis loss	115
6.13	Eddy currents	116
6.14	Real electronic components	118
6.15	Summary	119

bookboon.com

Corporate eLibrary

See our Business Solutions for employee learning

[Click here](#)

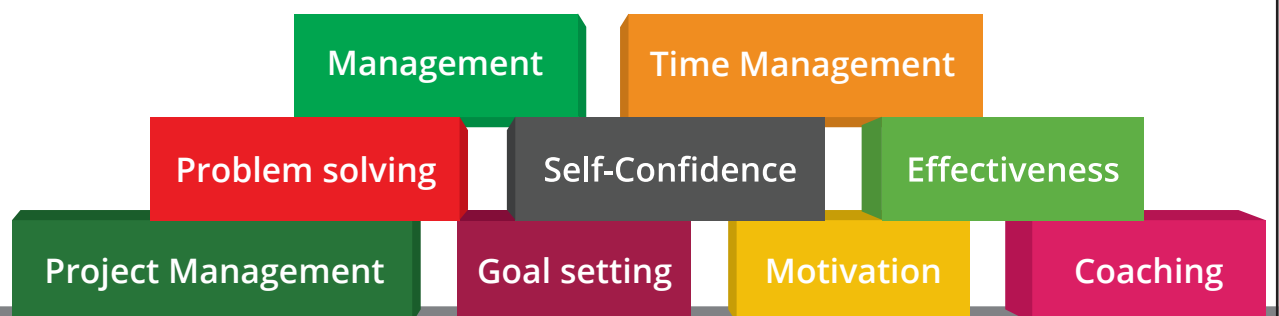

7	Transmission lines	120
7.1	Introduction	120
7.2	The circuit theory of transmission lines	121
7.3	Representation of waves using complex numbers	124
7.4	Characteristic impedance	125
7.5	Reflection of waves at the end of a line	126
7.6	Pulses on transmission lines	129
7.7	Reflection of pulses at the end of a line	131
7.8	Transformation of impedance along a transmission line	134
7.9	The coaxial line	137
7.10	The electric and magnetic fields in a coaxial line	139
7.11	Power flow in a coaxial line	140
7.12	Summary	142
8	Maxwell's equations and electromagnetic waves	143
8.1	Introduction	143
8.2	Maxwell's form of the magnetic circuit law	143
8.3	The differential form of the magnetic circuit law	146
8.4	The differential form of Faraday's law	148
8.5	Maxwell's equations	149

Brain power

By 2020, wind could provide one-tenth of our planet's electricity needs. Already today, SKF's innovative know-how is crucial to running a large proportion of the world's wind turbines.

Up to 25 % of the generating costs relate to maintenance. These can be reduced dramatically thanks to our systems for on-line condition monitoring and automatic lubrication. We help make it more economical to create cleaner, cheaper energy out of thin air.

By sharing our experience, expertise, and creativity, industries can boost performance beyond expectations. Therefore we need the best employees who can meet this challenge!

The Power of Knowledge Engineering

Plug into The Power of Knowledge Engineering.
Visit us at www.skf.com/knowledge

SKF

8.6	Plane electromagnetic waves in free space	151
8.7	Power flow in an electromagnetic wave	154
8.9	Summary	154
9	Bibliography	155
10	Appendix	158

With us you can
shape the future.
Every single day.

For more information go to:
www.eon-career.com

Your energy shapes the future.

e-on



Preface

Electromagnetism is fundamental to the whole of electrical and electronic engineering. It provides the basis for understanding the uses of electricity and for the design of the whole spectrum of devices from the largest turbo-alternators to the smallest microcircuits. This subject is a vital part of the education of electronic engineers. Without it they are limited to understanding electronic circuits in terms of the idealizations of circuit theory.

The book is, first and foremost, about electromagnetism, and any book which covers this subject must deal with its various laws. But you can choose different ways of entering its description and still, in the end, cover the same ground. I have chosen a conventional sequence of presentation, beginning with electrostatics, then moving to current electricity, the magnetic effects of currents, electromagnetic induction and electromagnetic waves. This seems to me to be the most logical approach.

Authors differ in the significance they ascribe to the four field vectors \mathbf{E} , \mathbf{D} , \mathbf{B} and \mathbf{H} . I find it simplest to regard \mathbf{E} and \mathbf{B} as 'physical' quantities because they are directly related to forces on electric charges, and \mathbf{D} and \mathbf{H} as useful inventions which make it easier to solve problems involving material media. For this reason the introduction of \mathbf{D} and \mathbf{H} is deferred until the points at which they are needed for this purpose.

Secondly, this is a book for those whose main interest is in electronics. The restricted space available meant that decisions had to be taken about what to include or omit. Where topics, such as the force on a charged particle moving in vacuum or an iron surface in a magnetic field, have been omitted, it is because they are of marginal importance for most electronic engineers. I have also omitted the chapter on radio-frequency interference which appeared in the second edition despite its practical importance.

Thirdly, I have written a book for engineers. On the whole engineers take the laws of physics as given. Their task is to apply them to the practical problems they meet in their work. For this reason I have chosen to introduce the laws with demonstrations of plausibility rather than formal proofs. It seems to me that engineers understand things best from practical examples rather than abstract mathematics. I have found from experience that few textbooks on electromagnetism are much help when it comes to applying the subject, so here I have tried to make good that deficiency both by emphasizing the strategies of problem-solving and the range of techniques available. A companion volume is planned to provide worked examples.

Most university engineering students already have some familiarity with the fundamentals of electricity and magnetism from their school physics courses. This book is designed to build on that foundation by providing a systematic treatment of a subject which may previously have been encountered as a set of experimental phenomena with no clear links between them. Those who have not studied the subject before, or who feel a need to revise the basic ideas, should consult the elementary texts listed in the Bibliography.

The mathematical techniques used in this book are all covered either at A-level or during the first year at university. They include calculus, coordinate geometry and vector algebra, including the use of dot and cross products. Vector notation makes it possible to state the laws of electromagnetism in concise general forms. This advantage seems to me to outweigh the possible disadvantage of its relative unfamiliarity. I have introduced the notation of vector calculus in order to provide students with a basis for understanding more advanced texts which deal with electromagnetic waves. No attempt is made here to apply the methods of vector calculus because the emphasis is on practical problem-solving and acquiring insight and not on the application of advanced mathematics.

I am indebted for my understanding of this subject to many people, teachers, authors and colleagues, but I feel a particular debt to my father who taught me the value of thinking about problems ‘from first principles’. His own book, *The Electromagnetic Field in its Engineering Aspects* (2nd edn, Longman, 1967) is a much more profound treatment than I have been able to attempt, and is well worth consulting.

I should like to record my gratitude to my editors, Professors Bloodworth and Dorey, of the white and red roses, to Tony Compton and my colleague David Bradley, all of whom read the draft of the first edition and offered many helpful suggestions. I am also indebted to Professor Freeman of Imperial College and Professor Sykulski of the University of Southampton for pointing out mistakes in my discussion of energy methods in the first edition.

Finally, I now realize why authors acknowledge the support and forbearance of their wives and families through the months of burning the midnight oil, and I am most happy to acknowledge my debt there also.

Richard Carter
Lancaster 2009

1 Electrostatics in free space

Objectives

- To show how the idea of the electric field is based on the inverse square law of force between two electric charges.
- To explain the principle of superposition and the circumstances in which it can be applied.
- To explain the concept of the flux of an electric field.
- To introduce Gauss' theorem and to show how it can be applied to those cases where the symmetry of the problem makes it possible.
- To derive the differential form of Gauss' theorem.
- To introduce the concept of electrostatic potential difference and to show how to calculate it from a given electric field distribution.
- To explain the idea of the gradient of the potential and to show how it can be used to calculate the electric field from a given potential distribution.
- To show how simple problems involving electrodes with applied potentials can be solved using Gauss' theorem, the principle of superposition and the method of images.
- To introduce the Laplace and Poisson equations.
- To show how the finite difference method can be used to find the solution to Laplace's equation for simple two-dimensional problems.

1.1 The inverse square law of force between two electric charges

The idea that electric charges exert forces on each other needs no introduction to anyone who has ever drawn a comb through his or her hair and used it to pick up small pieces of paper. The existence of electric charges and of the forces between them underlies every kind of electrical or electronic device. For the present we shall concentrate on the forces between charges which are at rest and on the force exerted on a moving charge by other charges which are at rest. The question of the forces between moving charges, which is a little more difficult, is dealt with in Chapter 4.

The science of phenomena involving stationary electric charges, known as **electrostatics**, finds many applications in electronics, including the calculation of capacitance and the theory of every type of active electronic device. Electrostatic phenomena are put to work in electrostatic copiers and paint sprays. They can also be a considerable nuisance, leading to explosions in oil tankers and the need for special precautions when handling metal-oxide semiconductor integrated circuits.

The starting point for the discussion of electrostatics is the experimentally determined law of force between two concentrated charges. This law, first established by Coulomb (1785), is that the force is proportional to the product of the magnitudes of the charges and inversely proportional to the square of the distance between them. In the shorthand of mathematics the law may be written

$$\mathbf{E} = \frac{Q_1}{4\pi\epsilon_0 r^2} \hat{\mathbf{r}} \quad (1.1)$$

where Q_1 and Q_2 are the magnitudes of the two charges and r is the distance between them, as shown in the figure on the right. Now force is a vector quantity, so Equation (1.1) includes the unit vector $\hat{\mathbf{r}}$ which is directed from Q_1 towards Q_2 and the equation gives the force exerted on Q_2 by Q_1 . The force exerted on Q_1 by Q_2 is equal and opposite, as required by Newton's third law of motion.

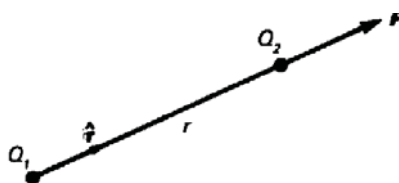

Examination of Equation (1.1) shows that it includes the effect of the polarity of the charges correctly, so that like charges repel each other while unlike charges attract. The symbol ϵ_0 denotes the **primary electric constant**; its value depends upon the system of units being used. In this book SI units are used throughout, as is now the almost universal practice of engineers. In this system of units ϵ_0 is measured in Farads per metre, and its experimental value is $8,854 \times 10^{-12} \text{ F m}^{-1}$; the SI unit of charge is the **coulomb (C)**.

Electric charge on a macroscopic scale is the result of the accumulation of large numbers of atomic charges each having magnitude $1.602 \times 10^{-19} \text{ C}$. These charges may be positive or negative, protons being positively charged and electrons negatively. In nearly all problems in electronics the electrons are movable charges while the protons remain fixed in the crystal lattices of solid conductors or insulators. The exceptions to this occur in conduction in liquids and gases, where positive ions may contribute to the electric current.

1.2 The electric field

Although Equation (1.1) is fundamental to the theory of electrostatics it is seldom, if ever, used directly. The reason for this is that we are usually interested in effects involving large numbers of charges, so that the use of Equation (1.1) would require some sort of summation over the (vector) forces on a charge produced by every other charge. This is not normally easy to do and, as we shall see later, the distribution of charges is not always known, though it can be calculated if necessary. Equation (1.1) can be divided into two parts by the introduction of a new vector \mathbf{E} , so that

$$\mathbf{E} = \frac{Q_1}{4\pi\epsilon_0 r^2} \hat{\mathbf{r}} \quad (1.2)$$

$$\text{and } \mathbf{F} = Q_2 \mathbf{E} \quad (1.3)$$

The vector \mathbf{E} is known as the electric field, and is measured in volts per metre in SI units. The step of introducing \mathbf{E} is important because it separates the source of the electric force (Q_1) from its effect on the charge Q_2 . The question of whether the electric field has a real existence or not is one which we can leave to the philosophers of science; its importance to engineers is that it is an effective tool for solving problems.

The electric field is often represented by diagrams like Fig. 1.1 in which the lines, referred to as 'lines of force', show the direction of \mathbf{E} . The arrowheads show the direction of the force which would act on a positive charge placed in the field. The spacing of the lines of force is close where the field is strong and wider where it is weak. This kind of diagram is a useful aid to thought about electric fields, so it is well worth while becoming proficient in sketching the field patterns associated with different arrangements of charges. We shall return to this point later, when discussing electric fields in the presence of conducting materials.

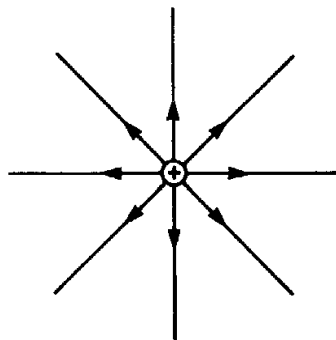

Fig.1.1 The electric field of a point charge can be represented diagrammatically by lines of force. The figure should really be three-dimensional, with the lines distributed evenly in all directions.

In order to move from the idea of the force acting between two point charges to that acting on a charge due to a whole assembly of other charges it is necessary to invoke the **principle of superposition**. This principle applies to any linear system, that is, one in which the response of the system is directly proportional to the stimulus producing it. The principle states that the response of the system to a set of stimuli applied simultaneously is equal to the sum of the responses produced when the stimuli are applied separately.

Equation (1.2) shows that the electric field in the absence of material media ('in free space') is proportional to the charge producing it, so the field produced by an assembly of charges is the vector sum of the fields due to the individual charges. The principle of superposition is very valuable because it allows us to tackle complicated problems by treating them as the sums of simpler problems. It is important to remember that the principle can be applied only to linear systems. The response of some materials to electric fields is non-linear and the use of the principle is not valid in problems involving them.

Before discussing ways of calculating the electric field it is worth noting why we might wish to do it.

The information might be needed to calculate:

- the forces on charges;
- the conditions under which voltage breakdown might occur;
- capacitance;
- the electrostatic forces on material media.

The last of these is put to use in electrostatic loudspeakers, copiers, ink-jet printers and paint sprays and is of growing importance in micro-mechanical devices.

© 2013 Accenture. All rights reserved.

be > your degree

Bring your talent and passion to a global organization at the forefront of business, technology and innovation. Discover how great you can be.

Visit accenture.com/bookboon

Be greater than.
consulting | technology | outsourcing

accenture
High performance. Delivered.

1.3 Gauss' theorem

Figure 1.1 shows electric field lines radiating from a charge in much the same way that flow lines in an incompressible fluid radiate from a source (such as the end of a thin pipe) immersed in a large volume of fluid (shown in Fig. 1.2). Now in the fluid the volume flow rate across a control surface such as S , which encloses the end of the pipe, must be independent of the surface chosen and equal to the flow rate down the pipe, that is, to the strength of the source.

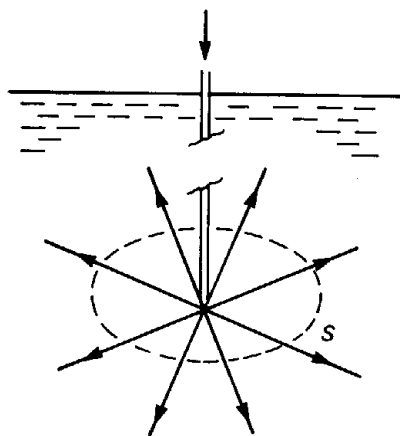
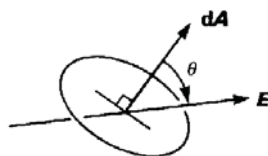

Fig. 1.2 The flow of an incompressible fluid from the end of a thin pipe is analogous to the electric field of a point charge. It is necessary for the end of the pipe to be well away from the surface of the fluid and the walls of the containing vessel

To apply this idea to the electric field it is necessary to define the equivalent of the flow rate which is known as the **electric flux**. The figure on the right shows a small element of surface of area dA and the local direction of the electric field \mathbf{E} . The flux of \mathbf{E} through dA is defined as the product of the area with the normal component of \mathbf{E} . This can be written very neatly using vector notation by defining a vector $d\mathbf{A}$ normal to the surface element. The flux of \mathbf{E} through $d\mathbf{A}$ is then just $\mathbf{E} \cdot d\mathbf{A} = E dA \cos \theta$.



Now consider the total flux coming from a point charge. The simplest choice of control surface (usually called a **Gaussian surface** in this context) is a sphere concentric with the charge. Equation (1.2) shows that \mathbf{E} is always normal to the surface of the sphere and its magnitude is constant there. This makes the calculation of the flux of \mathbf{E} out of the sphere easy – it is just the product of the magnitude of \mathbf{E} with the surface area of the sphere:

$$\text{flux of } \mathbf{E} = \frac{Q}{4\pi\epsilon_0 r^2} 4\pi r^2 = \frac{Q}{\epsilon_0} \tag{1.4}$$

Thus the flux of \mathbf{E} out of the sphere is independent of the radius of the sphere and depends only on the charge enclosed within it. It can be shown that this result is true for any shape of surface and, by using the principle of superposition, for any grouping of charges enclosed. The result may be stated in words:

The flux of \mathbf{E} out of any closed surface in free space is equal to the charge enclosed by the surface divided by ϵ_0 .

This is known as **Gauss' theorem**. It can also be written, using the notation of mathematics, as

$$\oiint_S \mathbf{E} \cdot d\mathbf{A} = \frac{1}{\epsilon_0} \iiint_V \rho \, dv \quad (1.5)$$

where S is a closed surface enclosing the volume V and ρ is the charge density within it. Equation (1.5) looks fearsome but, in fact, it is possible to apply it directly only in three cases whose symmetry allows the integrals to be evaluated. Those cases are:

- Parallel planes
- Concentric cylinders
- Concentric spheres

To show how this is done let us consider the case of a long, straight, rod of radius a carrying a uniform charge q per unit length. From the symmetry of the problem we can assume that \mathbf{E} is everywhere directed radially outwards and that the magnitude of \mathbf{E} depends only on the distance from the axis. This is not valid near the ends of the rod but the problem can be solved in this way only if this assumption is made. The next step is to define the Gaussian surface to be used. This is chosen to be a cylinder of radius r and unit length concentric with the charged cylinder with ends which are flat and perpendicular to the axis as shown in Fig. 1.3

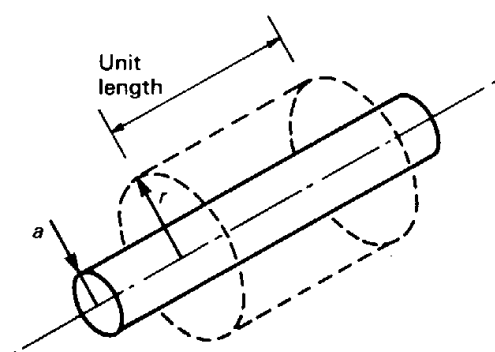

Fig. 1.3 A Gaussian surface for calculating the electric field strength around a charged rod.

On the curved part of the Gaussian surface \mathbf{E} has constant magnitude and is everywhere perpendicular to the surface. The flux of \mathbf{E} out of this part of the surface is therefore equal to the product of E and the area of the curved surface. On the ends of the cylinder \mathbf{E} is not constant but, since it is always parallel to the surface, the flux of \mathbf{E} out of the ends of the cylinder is zero. Finally, since the Gaussian surface is of unit length it encloses charge q . Therefore, from Gauss' theorem,

$$2\pi rE = q/\epsilon_0$$

$$\text{or } E = q/2\pi\epsilon_0 r \quad (1.6)$$

1.4 The differential form of Gauss' theorem

Only a limited range of problems can be solved by the direct use of Equation (1.5). Another form, which is obtained by applying it to a small volume element, enables us to solve a much wider range of problems. Figure 1.4 shows such a volume element in Cartesian coordinates.



"I studied English for 16 years but...
...I finally learned to speak it in just six lessons"
Jane, Chinese architect

ENGLISH OUT THERE

Click to hear me talking before and after my unique course download

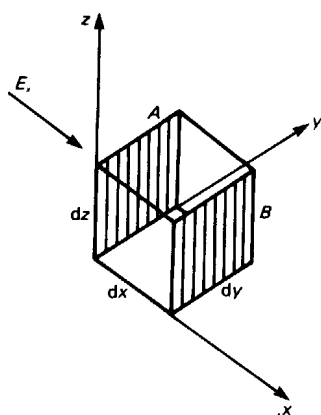

Fig. 1.4 The elementary Gaussian surface used to derive the differential form of Gauss' theorem.

To calculate the net flux out of the element, consider first the two shaded faces A and B which are perpendicular to the x -axis. The only component of \mathbf{E} which contributes to the flux through these faces is E_x . If the component of \mathbf{E} is E_x on A then, in general, the x component of \mathbf{E} on B can be written $E_x + (\partial E_x / \partial x) dx$. Provided that the dimensions of the element are small enough we can assume that these components are constant on the surfaces A and B. The flux of \mathbf{E} out of the volume through the faces A and B is then

$$- E_x dy dz + \left(E_x + \frac{\partial E_x}{\partial x} dx \right) dy dz = \frac{\partial E_x}{\partial x} dx dy dz$$

The same argument can be used for the other two directions in space, with the result that the net flux of \mathbf{E} out of the element is

$$d\Phi_E = \left(\frac{\partial E_x}{\partial x} + \frac{\partial E_y}{\partial y} + \frac{\partial E_z}{\partial z} \right) dx dy dz \tag{1.7}$$

Now if ρ is the local charge density, which may be assumed to be constant if the volume element is small enough, the charge enclosed in the volume is

$$dQ = \rho dx dy dz \tag{1.8}$$

Applying Gauss' theorem to the element and making use of Equations (1.7) and (1.8) gives the differential form of Gauss' theorem:

$$\left(\frac{\partial E_x}{\partial x} + \frac{\partial E_y}{\partial y} + \frac{\partial E_z}{\partial z} \right) = \frac{\rho}{\epsilon_0} \tag{1.9}$$

The expression on the left-hand side of Equation (1.9) is known as the **divergence** of \mathbf{E} . It is sometimes written as $\text{div } \mathbf{E}$. The same expression can also be written as the dot product between the differential operator

$$\nabla = \left(\hat{\mathbf{x}} \frac{\partial}{\partial x} + \hat{\mathbf{y}} \frac{\partial}{\partial y} + \hat{\mathbf{z}} \frac{\partial}{\partial z} \right) \quad (1.10)$$

and the vector \mathbf{E} . In Equation (1.10) $\hat{\mathbf{x}}, \hat{\mathbf{y}}, \hat{\mathbf{z}}$ are unit vectors along the x -, y - and z -axes. Using the symbol ∇ , which is known as 'del'. Equation (1.9) can be written

$$\nabla \cdot \mathbf{E} = \frac{\rho}{\epsilon_0} \quad (1.11)$$

This abbreviation is not as pointless as it seems because Equation (1.11) is valid for all systems of coordinates in which the coordinate surfaces intersect at right angles. An appropriate form for ∇ can be found for each such coordinate system.

1.5 Electrostatic potential

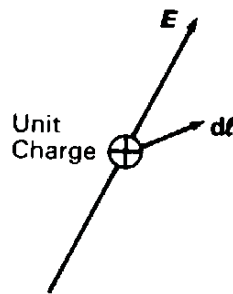

The electric field is inconvenient to work with because it is a vector; it would be much simpler to be able to work with scalar variables. The **electrostatic potential difference** (V) between two points in an electric field is defined as the work done when unit positive charge is moved from one point to the other. Consider the figure on the right. The force on the charge is \mathbf{E} , from Equation (1.3), so the external force needed to hold it in equilibrium is $-\mathbf{E}$. The work done on the charge by the external force when it is moved through a small distance $d\mathbf{l}$ is the product of the external force and the distance moved in the direction of that force. Thus the change in electrostatic potential is

$$dV = -\mathbf{E} \cdot d\mathbf{l} \quad (1.12)$$

The potential difference between two points A and B can be calculated by integrating Equation (1.12) along any path between them. Mathematically this is written

$$V_B - V_A = -\int_A^B \mathbf{E} \cdot d\mathbf{l} \quad (1.13)$$

This kind of integral is called a **line integral**. This is a slightly tricky concept, but its application is limited in practice to cases where the symmetry of the problem makes its evaluation possible.

The electrostatic potential is analogous to gravitational potential, which is defined as the work done in moving a unit mass against gravity from one point to another. The change in the gravitational potential depends only upon the relative heights of the starting and finishing points and not on the path which is taken between them. We can show that the same is true for the electrostatic potential. Figure 1.5 shows a possible path between two points A and B in the presence of the electric field due to a point charge Q at O .

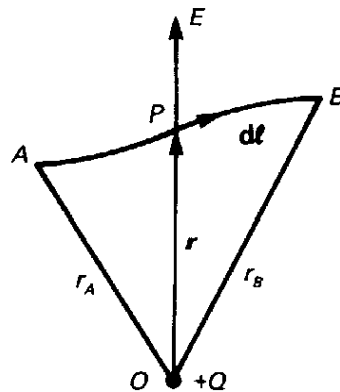

Fig. 1.5 When a charge is moved from A to B in the field of another charge at O the change in electrostatic potential is found to be independent of the choice of the path APB . It depends only on the positions of the ends of the path.



DUKE
THE FUQUA
SCHOOL
OF BUSINESS



HERE.

BUSINESS HAPPENS

www.fuqua.duke.edu/globalmba

Learn More >

The contribution to the integral of Equation (1.13) from a small movement $d\mathbf{l}$ of a unit charge at P is

$$dV = -\frac{Q}{4\pi\epsilon_0 r^2} \hat{\mathbf{r}} \cdot d\mathbf{l} \quad (1.14)$$

But the dot product $\hat{\mathbf{r}} \cdot d\mathbf{l}$ is simply a way of writing ‘the component of $d\mathbf{l}$ in the radial direction’ using mathematical notation, and this quantity is just dr , the change in the distance from O . Thus Equation (1.14) can be integrated to give

$$V_B - V_A = -\int_A^B \frac{Q}{4\pi\epsilon_0 r^2} dr = \frac{Q}{4\pi\epsilon_0} \left(\frac{1}{r_B} - \frac{1}{r_A} \right) \quad (1.15)$$

The potential difference between A and B therefore depends only on their positions and not on the path taken between them. By using the principle of superposition we can extend this proof to the field of any combination of charges.

Potential differences are measured in volts. They are familiar to electronic engineers from their role in the operation of electronic circuits. It is important to remember that potentials are always relative. Any convenient point can be chosen as the zero of potential to which all other voltages are referred. Electronic engineers are inclined to speak loosely of the voltage at a point in a circuit when strictly they mean the voltage relative to the common rail. It is as well to keep this point in mind.

It follows from the preceding discussion that the line integral of the electric field around a closed path is zero. This is really a formal way of saying that the principle of conservation of energy applies to the motion of charged particles in electric fields. In mathematical symbols the line integral around a closed path is indicated by adding a circle to the integral sign so that

$$\oint \mathbf{E} \cdot d\mathbf{l} = 0 \quad (1.16)$$

The principle of conservation of energy often provides the best way of calculating the velocities of charged particles in electric fields.

1.6 Calculation of potential in simple cases

In simple cases where the electric field can be calculated by using Gauss’ theorem it is possible to calculate the potential by using Equation (1.13). More complicated problems can be solved by using the principle of superposition. Since scalar quantities are much easier to add than vectors it is best to superimpose the potentials rather than the fields.

To show how this is done let us consider Fig 1.6 which shows a cross-sectional view of two long straight cylindrical rods each of radius a . The rods are parallel to each other with their centre lines d apart. Rod A carries a charge q per unit length uniformly distributed and rod B carries a similar charge $-q$. We wish to find an expression for the electrostatic potential at any point on the plane passing through the centre lines of the rods.

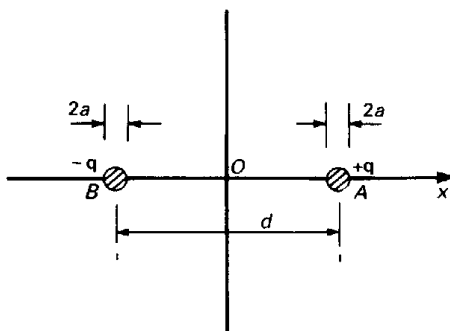

Fig. 1.6 A cross-sectional view of a parallel-wire transmission line.

The electric field of either rod on its own can be found by applying Gauss’ theorem as described above with the result given by Equation (1.6). Since \mathbf{E} is everywhere radial it follows that V depends only on r and

$$V = -\int \frac{q}{2\pi\epsilon_0 r} dr = -\frac{q}{2\pi\epsilon_0} \ln r + \text{constant} \tag{1.17}$$

where the constant of integration can be given any convenient value because the zero of potential is arbitrary.

It is appropriate to choose the origin of coordinates to be at O , mid-way between the rods, because of the symmetry of the problem, so that OA lies along the x -axis. Then for rod A, $r = |x - d/2|$. The same argument can be used for rod B, giving an expression for the potential which is identical to (1.17) except that the sign is reversed and $r = |x + d/2|$. Superimposing these two results and substituting the appropriate expressions for the radii we get:

$$V = \frac{q}{2\pi\epsilon_0} \ln \left| \frac{2x + d}{2x - d} \right| \tag{1.18}$$

where the constant of integration has been set equal to zero. This choice makes $V = 0$ when $x = 0$. The same method could be used to find a general expression for the potential at any point in space.

1.7 Calculation of the electric field from the potential

We have so far been concerned with means of calculating the potential from the electric field. In many cases it is necessary to reverse the process and calculate the field from a known potential distribution. Figure 1.7 shows how a small movement $d\mathbf{l}$ may be expressed in terms of its components as

$$d\mathbf{l} = \hat{\mathbf{x}} dx + \hat{\mathbf{y}} dy + \hat{\mathbf{z}} dz \tag{1.19}$$

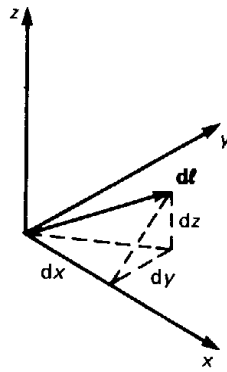

Fig. 1.7 A small vector $d\mathbf{l}$ can be regarded as the sum of vectors $d\mathbf{x}$, $d\mathbf{y}$ and $d\mathbf{z}$ along the coordinate directions

The electric field may likewise be expressed in terms of its components

$$E = \hat{\mathbf{x}} E_x + \hat{\mathbf{y}} E_y + \hat{\mathbf{z}} E_z \quad (1.20)$$

Then from Equations (1.12), (1.19) and (1.20) the potential change along $d\mathbf{l}$ is given by

$$\begin{aligned} dV &= -(\hat{\mathbf{x}} E_x + \hat{\mathbf{y}} E_y + \hat{\mathbf{z}} E_z) \cdot (\hat{\mathbf{x}} dx + \hat{\mathbf{y}} dy + \hat{\mathbf{z}} dz) \\ &= -(E_x dx + E_y dy + E_z dz) \end{aligned} \quad (1.21)$$

Join American online LIGS University!

Interactive Online programs
BBA, MBA, MSc, DBA and PhD

Special Christmas offer:

- ▶ enroll **by December 18th, 2014**
- ▶ **start studying and paying only in 2015**
- ▶ **save up to \$ 1,200** on the tuition!
- ▶ Interactive Online education
- ▶ visit ligsuniversity.com to find out more!

Note: LIGS University is not accredited by any nationally recognized accrediting agency listed by the US Secretary of Education. More info [here](#).



Click on the ad to read more

Setting $dy = dz = 0$ we have, for a movement in the x -direction,

$$E_x = -\frac{\partial V}{\partial x}$$

with similar expressions for the other two coordinate directions. By superposition the total electric field is

$$\mathbf{E} = -\left(\hat{\mathbf{x}}\frac{\partial V}{\partial x} + \hat{\mathbf{y}}\frac{\partial V}{\partial y} + \hat{\mathbf{z}}\frac{\partial V}{\partial z}\right) \quad (1.22)$$

The expression in parentheses on the right-hand side of Equation (1.22) is termed the gradient of V . It can be obtained by operating on V with the operator ∇ defined by Equation (1.10) so that Equation (1.22) may be written

$$\mathbf{E} = -\text{grad}V = -\nabla V \quad (1.23)$$

This equation, like Equation (1.11), can be written in terms of any orthogonal coordinate system by using the appropriate form for ∇V .

From Equation (1.12) it can be seen that if $d\mathbf{l}$ lies in such a direction that V is constant it must be perpendicular to \mathbf{E} . Surfaces on which V is constant are known as **equipotential surfaces** or just **equipotentials**. They always intersect the lines of \mathbf{E} at right angles. It has already been mentioned that field plots are useful aids to thought in electrostatics. They can be made even more useful by the addition of the equipotentials. Figure 1.8 shows, as an example, the field plot for the parallel wires of Fig. 1.6.

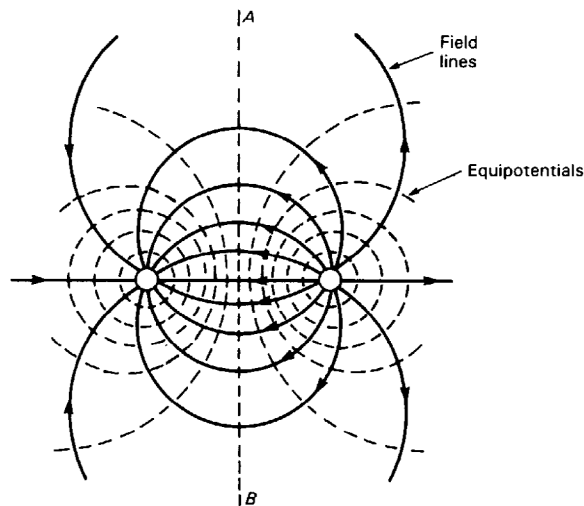

Fig. 1.8 The field pattern around a parallel-wire transmission line

1.8 Conducting materials in electrostatic fields

A conducting material in the present context is one which allows free movement of electric charge within it on a time scale which is short compared with that of the problem. Under this definition metals are always conductors but some other materials which are insulators on a short time scale may allow a redistribution of charge on a longer one. They may be regarded as conducting materials in electrostatic problems if we are prepared to wait for long enough for the charges to reach equilibrium. The charge distribution tends to equilibrium as $\exp(-t/\tau)$, where the time constant τ is known as **the relaxation time**. Some typical values are:

copper	1.5×10^{-19} s
distilled water	10^6 s
fused quartz	10^6 s

Once the charges have reached equilibrium there can be no force acting on them and the electric field within the material must be zero.

When an uncharged conducting body is placed in an electric field, the free charges within it must redistribute themselves to produce zero net field within the body. Consider, for example, a copper sphere placed in a uniform electric field. The copper has within it about 10^{29} conduction electrons per cubic metre, and their charge is balanced by the equal and opposite charge of the ionic cores fixed in the crystal lattice. The available conduction charge is of the order of 10^{10} C m⁻³, and only a tiny fraction of this charge has to be redistributed to cancel any practicable electric field. This redistribution gives rise to a surface charge, somewhat as shown in Fig. 1.9, whose field within the sphere is exactly equal and opposite to the field into which the sphere has been placed.

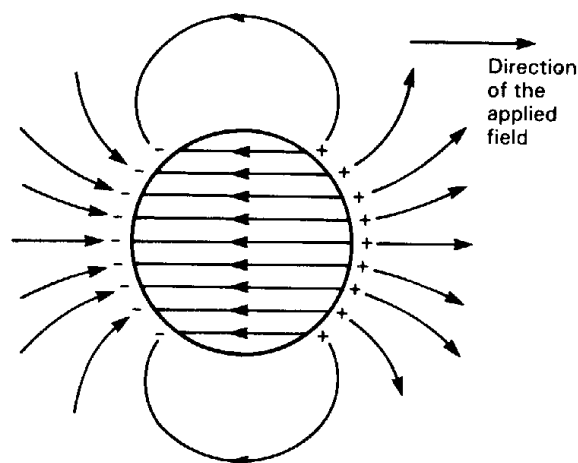

Fig. 1.9 The field pattern of the charge induced on a conducting sphere placed in a uniform electric field.

This surface charge is known as **induced charge**. It is important to remember that the positive and negative charges balance so that the sphere still carries no net charge. The complete solution to the problem is obtained by superimposing the original uniform field on that shown in Fig. 1.9 to give the field shown in Fig. 1.10. Note that the flux lines must meet the surface of the sphere at right angles because the surface is an equipotential.

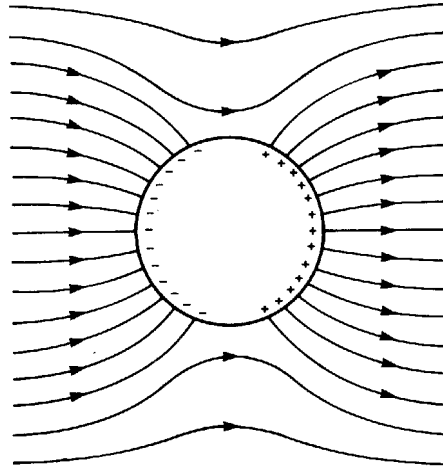

Fig. 1.10 The field pattern around a conducting sphere placed in a uniform electric field. This pattern is obtained by superimposing the field of the induced charges (shown in Fig. 1.9) on the uniform field.



#1 EUROPEAN
BUSINESS
SCHOOL

FINANCIAL TIMES
2013

MASTER IN MANAGEMENT

Because achieving your dreams is your greatest challenge. IE Business School's Master in Management taught in English, Spanish or bilingually, trains young high performance professionals at the beginning of their career through an innovative and stimulating program that will help them reach their full potential.

- Choose your area of specialization.
- Customize your master through the different options offered.
- Global Immersion Weeks in locations such as Rio de Janeiro, Shanghai or San Francisco.

Because you change, we change with you.

www.ie.edu/master-management

mim.admissions@ie.edu







#gobeyond

Not only is there no electric field within a conducting body, but there is also no field within a closed conducting shell placed in an electric field. To prove this, consider the figure on the right, which shows a closed conducting shell S_1 . This must be an equipotential surface. If there is any electric field within S_1 there must be other equipotentials such as S_2 lying wholly within S_1 . Now the interior of the shell contains no free charge so, applying Gauss' theorem to S_2 , the flux of \mathbf{E} out of S_2 is zero. But, since it has been postulated that S_2 is an equipotential surface, this can be true only if \mathbf{E} is zero everywhere on it and the potential of S_2 is the same as that of S_1 .

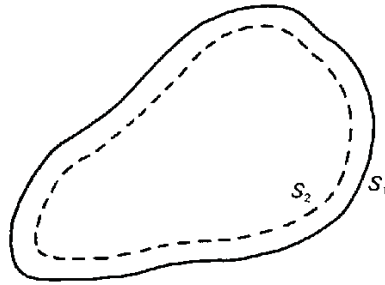

A closed hollow earthed conductor can therefore be used to screen sensitive electronic equipment from electrostatic interference. The screening is perfect as long as there are no holes in the enclosure, for example to allow wires to pass through. Even when there are holes in the enclosure the screening can still be quite effective, for reasons which will be discussed in the next chapter. When the electric field varies with time other screening mechanisms come into play and the screening is no longer so perfect.

1.9 The method of images

We have already seen that the electric field produced by a known distribution of charges can be calculated in simple cases, by the application of Gauss' theorem and the principle of superposition. In most practical problems, however, the charge is unknown and the problem is specified in terms of the potentials on electrodes. Simple problems of this type can be solved by the use of Gauss' theorem if it is possible to make assumptions about the distribution of charges from the symmetry of the problem.

If an uncharged, isolated, conducting sheet is placed in an electric field, then equal positive and negative charges are induced on it. Normally this process requires currents to flow in the plane of the sheet, and the field pattern is changed so that the sheet becomes an equipotential surface. If, however, the sheet is arranged so that it coincides with an equipotential surface, the direction of current flow is normal to the plane of the sheet and the two surfaces become oppositely charged. If the sheet is thin, the separation of the positive and negative charges is small and the field pattern is not affected by the presence of the sheet. This fact can be used to extend the range of problems which can be solved by elementary methods. For example, a conducting sheet can be placed along the equipotential AB in Fig. 1.8. It screens the two charged wires from each other so that either could be removed without affecting the field pattern on the other side of the sheet. Thus the field pattern between a charged wire and a conducting plane is just half of that of a pair of oppositely charged conducting wires.

The field between a charged wire and a conducting plane can be found by reversing the train of thought. We note that an **image charge** can be placed on the opposite side of the plane to produce a field which is the mirror image of the original field. The image charge is equal in magnitude to the original charge, but has the opposite sign. The plane is an equipotential surface in the field of the two charges, so it can be removed without altering the field pattern. The problem is then reduced to the superposition of the fields of the original and image charges. This method is known as the **method of images**. It can be applied to the solution of any problem involving charges and conducting surfaces if a set of image charges can be found such that the equipotentials in free space of the whole set of charges coincide with the conducting boundaries.

1.10 Laplace's and Poisson's equations

The method described in the previous section has been applied with ingenuity to a wide variety of problems whose solutions can be looked up when required. Unfortunately engineers are not free to choose the problems they wish to solve, and the great majority of practical problems cannot be solved by elementary methods. Figure 1.11 shows a typical problem: an electron gun of the kind used to generate the electron beam in a microwave tube for satellite communications.

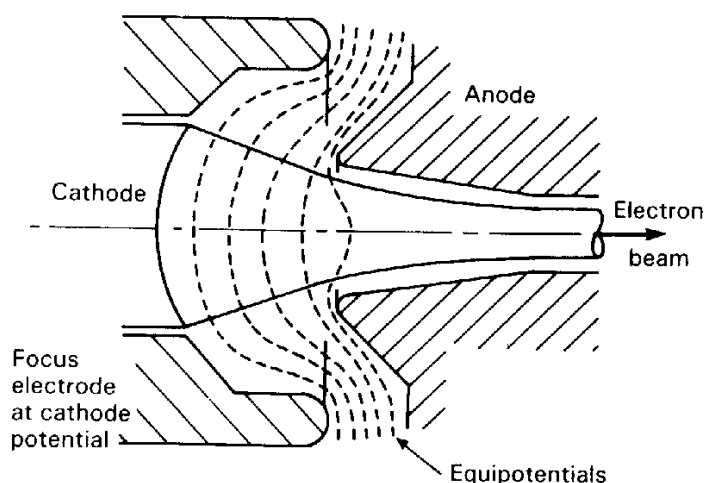

Fig. 1.11 The arrangement of a typical high-power electron gun. Such a gun might produce a 50 mA electron beam 2 mm in diameter for a potential difference between cathode and anode of 5 kV.

In this case the field problem and the equations of motion of the electrons must be solved simultaneously because the space charge of the electrons affects the field solution. A general method which can be used, in principle, to solve any problem is obtained by combining Equations (1.9) and (1.22) to give

$$\frac{\partial^2 V}{\partial x^2} + \frac{\partial^2 V}{\partial y^2} + \frac{\partial^2 V}{\partial z^2} = -\frac{\rho}{\epsilon_0} \quad (1.24)$$

This is known as **Poisson's equation**. It can also be written

$$\nabla^2 V = -\frac{\rho}{\epsilon_0} \quad (1.25)$$

where ∇^2 is given, in rectangular Cartesian coordinates, by

$$\nabla^2 = \frac{\partial^2}{\partial x^2} + \frac{\partial^2}{\partial y^2} + \frac{\partial^2}{\partial z^2} \quad (1.26)$$

When there is no free charge present the equation takes the simpler form known as **Laplace's equation**:

$$\nabla^2 V = \frac{\partial^2 V}{\partial x^2} + \frac{\partial^2 V}{\partial y^2} + \frac{\partial^2 V}{\partial z^2} = 0 \quad (1.27)$$

This equation has been solved for a very wide range of boundary conditions by analytical methods employing a variety of coordinate systems and by the special method known as **conformal mapping**, which applies to two-dimensional problems. These solutions can be looked up when they are required. Cases whose solutions are not available in the literature must, in nearly every case, be solved by numerical methods. When free charges are present in a problem it is necessary to use Poisson's equation as the basis of either an analytical or a numerical solution. There are only a few cases which can be solved analytically.

SMS from your computer

...Sync'd with your Android phone & number

FREE
30 days trial!

Go to

BrowserTexting.com

and start texting from
your computer!

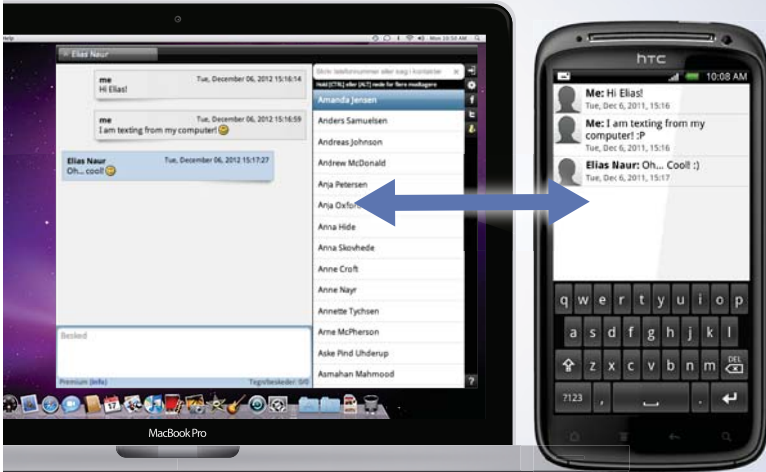

BrowserTexting

In every kind of active electronic device electric fields are used to control the motion of charged particles. The methods described here can be applied to the motion of charged particles in vacuum. When the charge densities are small it is possible to calculate the electrostatic fields, neglecting the contributions of the charges to them, and then to integrate the equations of motion of the particles. At higher charge densities the fields are affected by the space charge and it is necessary to find mutually consistent solutions of Poisson's equation and the equations of motion. The motion of charge carriers in semiconductor devices such as transistors requires knowledge of the fields in material media as discussed in Chapter 2.

1.11 The finite difference method

The simplest numerical method for solving field problems is the **finite difference method**. In this method a regular rectangular mesh is superimposed upon the problem. The real continuous variation of potential with position is then approximated by the values of the potential at the intersections of the mesh lines. Figure 1.12 shows a small section of a two-dimensional mesh with a spacing h in each direction and the electrostatic potentials at the mesh points.

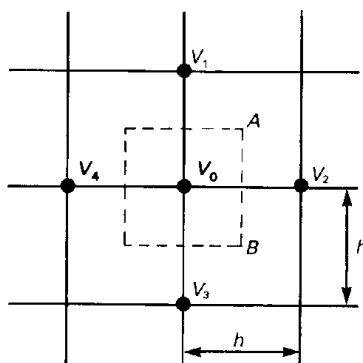

Fig. 1.12 Basis of the finite difference calculation of potential.

To find an approximate relationship between the potentials shown we apply Gauss' theorem to the surface shown by the broken line. The component of the electric field normal to the section AB of the surface is given approximately by

$$E_{nAB} = (V_0 - V_2)/h \quad (1.28)$$

The flux of \mathbf{E} through unit depth of the face AB is therefore

$$\begin{aligned} \Phi_{AB} &= E_{nAB} h \\ &= V_0 - V_2 \end{aligned} \quad (1.29)$$

If the Gaussian surface does not enclose any charge the net flux of \mathbf{E} out of it must be zero so that

$$\begin{aligned} 4V_0 - V_1 - V_2 - V_3 - V_4 &= 0 \\ \text{or } V_0 &= \frac{1}{4}(V_1 + V_2 + V_3 + V_4) \end{aligned} \quad (1.30)$$

Thus, if we know the potentials at points 1 to 4 approximately, we can use Equation (1.30) to obtain an estimate of V_0 . Because the errors in the four potentials cancel each other out to some extent, and because the resulting error is divided by 4, the error in the value of V_0 is normally less than the errors in the potentials used to calculate it. Equation (1.30) is conveniently summarized by the diagram on the right.

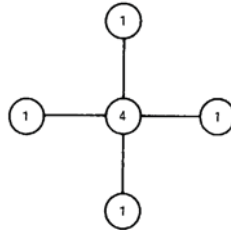

This method can be used to find the fields around two-dimensional arrangements of electrodes on which the potentials are specified such as the concentric square tubes shown in the figure on the right. The method can be implemented on a spreadsheet as follows:

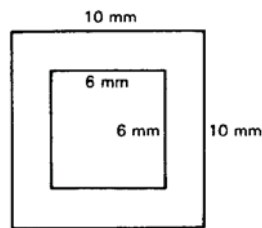

- A uniform square mesh is defined such that the electrodes coincide with mesh lines. The mesh spacing is chosen so that it is small enough to provide a reasonably detailed approximation to the fields whilst not being so small that the computational time is very large.
- Cells of the spreadsheet are marked out such that one cell corresponds to each mesh point. The symmetry of the problem can be used to reduce the number of cells required. Thus, for the geometry shown above it is sufficient to find the solution for one quadrant of the problem.
- The electrode potentials are entered into the cells corresponding to the electrodes and the formula in Equation (1.30) is entered into all the other cells. When symmetry has been used to reduce the size of the problem the formulae in the cells along symmetry boundaries make use of the fact that the potentials on either side of the boundary are equal.
- The formulae in the cells are then applied repeatedly (a process known as **iteration**) until the numbers in the cells cease to change. To do this the calculation options of the spreadsheet must be set to permit iteration. The final numbers in the cells are then approximations to the potentials at the corresponding points in space.
- From this solution the equipotential curves can be plotted by interpolation between the potentials at the mesh points and the field components can be calculated at any mesh point.

The method can be applied to more complicated problems including those with curved electrodes which do not fit the mesh and three-dimensional problems. Further information can be found in the literature.

1.12 Summary

In this chapter, starting from the inverse square law of force between two charges, we have derived a range of methods for solving practical problems involving electric fields in free space. The concepts of electric field, flux density and potential have been shown to be useful for these purposes. The ideas contained in this chapter find their direct application in problems about voltage breakdown between electrodes in air and those dealing with the motion of charged particles in vacuum.

The very limited range of problems which can be solved by elementary methods can be extended by the use of the principle of superposition and the method of images. In most real problems, however, the electric field can be calculated only by solving Laplace's or Poisson's equations. Cases which have not been solved before generally have to be tackled using numerical methods.

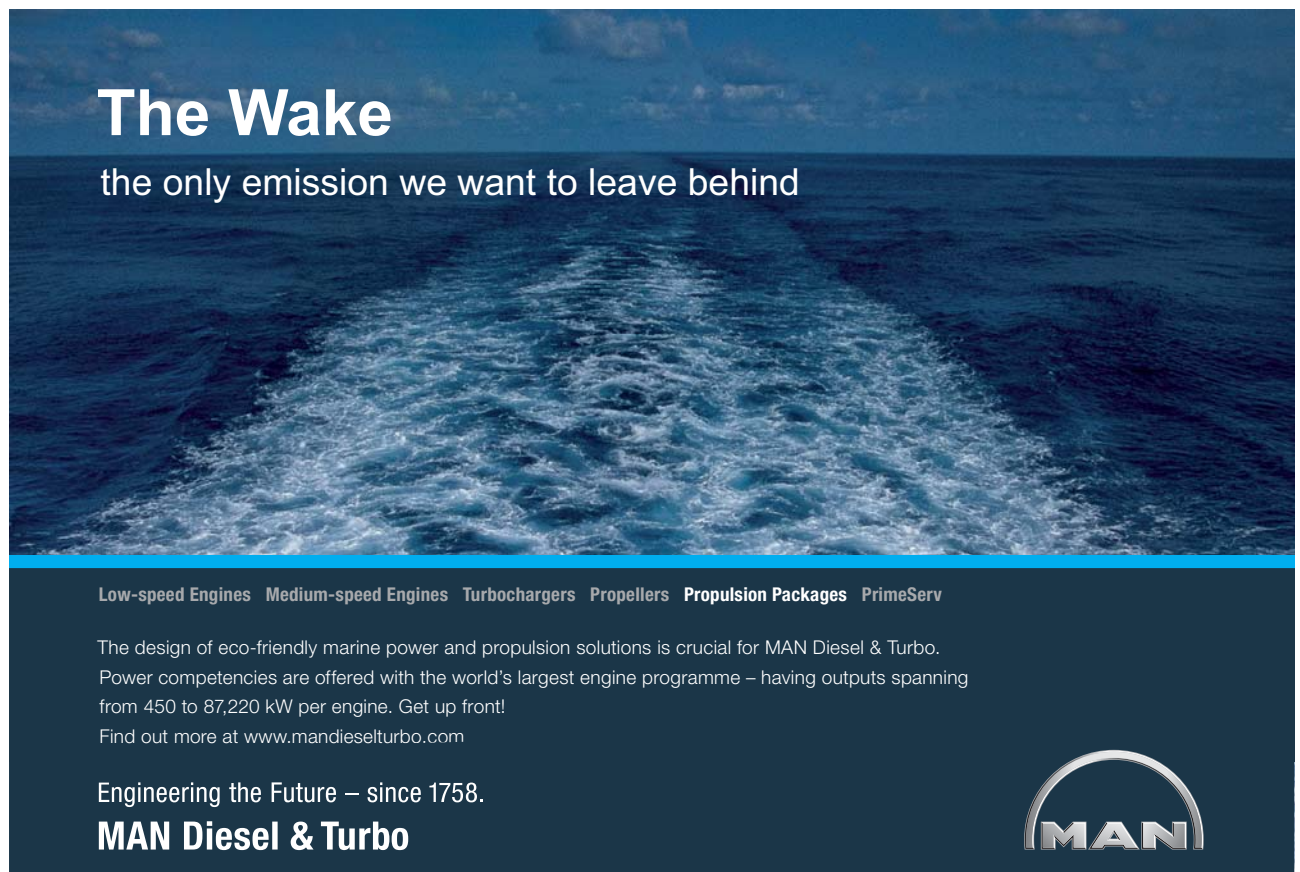

The Wake
the only emission we want to leave behind

Low-speed Engines Medium-speed Engines Turbochargers Propellers Propulsion Packages PrimeServ

The design of eco-friendly marine power and propulsion solutions is crucial for MAN Diesel & Turbo. Power competencies are offered with the world's largest engine programme – having outputs spanning from 450 to 87,220 kW per engine. Get up front!
Find out more at www.mandieselturbo.com

Engineering the Future – since 1758.
MAN Diesel & Turbo



2 Dielectric materials and capacitance

Objectives

- To discuss how and why an electric field is affected by the presence of dielectric materials
- To introduce the electric flux density vector \mathbf{D} as a useful tool for solving problems involving dielectric materials.
- To derive the boundary conditions which apply at the interface between different dielectric materials.
- To introduce the idea of capacitance as a general phenomenon which is not restricted to capacitors.
- To demonstrate the calculation of capacitance by the use of Gauss' theorem, field solutions and energy methods.
- To introduce the idea of stored energy density in an electric field.
- To discuss the causes of electrostatic interference and techniques for reducing it.

2.1 Insulating materials in electric fields

Very many materials do not allow electric charges to move freely within them, or allow such motion to occur only very slowly. These materials are not only used to block the flow of electric current but also to form the insulating layer between the electrodes of capacitors. In this context they are known as **dielectric materials**. By making an appropriate choice of dielectric material for a capacitor it is possible to reduce the size of a capacitor of given capacitance or to increase its working voltage.

If a dielectric material is subjected to a high enough electric field it becomes a conductor of electricity, undergoing what is known as **dielectric breakdown**. This controls the maximum working voltage of capacitors, the maximum power which can be handled by coaxial cables in high-power applications such as radio transmitters, and the maximum voltages which can be sustained in microcircuits. It is not always appreciated that because dielectric breakdown depends on the electric field strength it can occur when low voltages are applied across very thin pieces of dielectric material.

In order to understand the behaviour of dielectric materials in electric fields it is helpful to make a comparison with that of conductors. Figures 2.1 (a) and (b) show respectively a conducting sheet and a dielectric sheet placed between parallel electrodes to which a potential difference has been applied. The potential difference is associated with equal and opposite charges on the two electrodes.

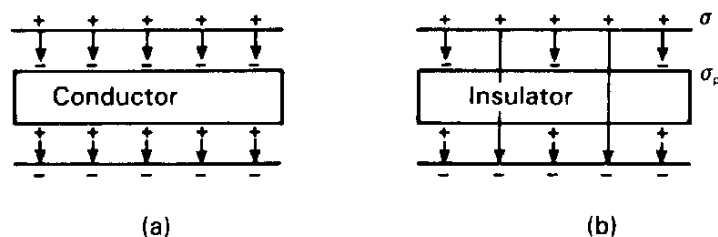

Fig. 2.1 Comparison between (a) a conductor and (b) an insulator placed in an electric field.

The conducting sheet of Fig. 2.1 (a) contains electrons which are free to move and set up a surface charge which exactly cancels the electric field within the conductor in the manner discussed in Chapter 1. The electrons in the dielectric material, on the other hand, are bound to their parent atoms and can only be displaced to a limited extent by the applied electric field. This displacement, however, is sufficient to produce some surface charge and the dielectric is then said to be **polarized**. The surface charge is not sufficient to cancel the electric field within the sheet, but it does reduce it to some extent, as shown in Fig. 2.1 (b).

Polarization may also produce a volume distribution of charge, but we shall assume that this does not occur in the materials in which we are interested. It is important to remember that the surface charge produced by the polarization of a dielectric is a bound charge which, unlike the surface charge induced on a conductor, cannot be removed. The polarization charges must also be carefully distinguished from any free charge which may reside on the surface of a dielectric.

On materials which are good insulators, free charges may persist for long periods and strong electric fields may build up as a result of them. These phenomena have many important practical consequences, but they are not easy to study theoretically because the distribution of the charges is usually unknown. In metal oxide semiconductor (MOS) integrated circuits, for example, it is possible for charges to build up on the gate electrodes if they are left unconnected. The electric field produced by these charges can be strong enough to cause dielectric breakdown of the silicon dioxide layer. This is why special precautions have to be taken when handling these circuits. In what follows we shall assume that the dielectric is initially uncharged and that any surface charge is the result of polarization.

To put this subject on a quantitative basis, let us suppose that the electrodes in Fig. 2.1 (b) carry a surface charge σ per unit area and that the surface charge on the dielectric is σ_p per unit area. Now, assuming that the electric field is everywhere uniform and normal to the electrodes, it can be shown that the field outside the dielectric is given by

$$E_a = \frac{\sigma}{\epsilon_0} \quad (2.1)$$

This result is obtained by applying Gauss' Theorem to the field between plane, parallel, electrodes. Similarly the field within the dielectric is

$$E_d = \frac{\sigma - \sigma_p}{\epsilon_0} \quad (2.2)$$

Equation (2.2) can be rewritten as

$$E_d = \left(\frac{\sigma - \sigma_p}{\sigma} \right) \frac{\sigma}{\epsilon_0} = \frac{\sigma}{\epsilon_0 \epsilon_r} \quad (2.3)$$

where $\epsilon_r = \sigma / (\sigma - \sigma_p)$ is known as the **relative permittivity** of the material. Since $\sigma_p < \sigma$ it follows that $\epsilon_r > 1$. It is unfortunate that the symbol ϵ_r has been adopted for this property of dielectric materials because there could be some confusion between it (a dimensionless quantity) and the **permittivity**, defined as $\epsilon = \epsilon_0 \epsilon_p$ and measured in Farads per metre. Care must be taken not to get these symbols confused with each other.

TURN TO THE EXPERTS FOR SUBSCRIPTION CONSULTANCY

Subscribe is one of the leading companies in Europe when it comes to innovation and business development within subscription businesses.

We innovate new subscription business models or improve existing ones. We do business reviews of existing subscription businesses and we develop acquisition and retention strategies.

Learn more at [linkedin.com/company/subscribe](https://www.linkedin.com/company/subscribe) or contact Managing Director Morten Suhr Hansen at mha@subscribe.dk

SUBSCRIB✓**BE** - to the future

In order to make the theory simpler, we shall assume that σ_p is proportional to σ and that ϵ_r is therefore a constant. This assumption holds good for many of the materials used in electronic engineering, but it is very important to remember that it is not always valid. In particular, for some materials, ϵ_r may depend on:

- the strength of the electric field;
- frequency (if the field is varying with time);
- the orientation of crystal axes to the field;
- the previous history of the material.

Problems involving linear dielectric materials could be solved by calculating the polarization charges and finding the fields resulting from both the free charges on the electrodes and the bound polarization charges. This would not usually be easy and it is much better to use an approach in which the polarization charges are implicit. To do this we introduce a new vector known as the **electric flux density**, which is defined by

$$\mathbf{D} = \epsilon \mathbf{E} \quad (2.4)$$

In the example given above the electric flux density outside the dielectric is $D = \sigma$ and that within the dielectric is likewise σ . In other words \mathbf{D} depends only on the free charges, unlike \mathbf{E} , which depends on the polarization charges as well.

It can be shown that, subject to the validity of the assumption that ϵ_r is a constant, the argument given above can be generalized to cover pieces of dielectric material of any shape. Gauss' theorem (Equation (1.5)) can thus be written in a form which is valid for problems involving dielectric materials:

$$\oiint \mathbf{D} \cdot d\mathbf{S} = \iiint \rho \, dv \quad (2.5)$$

or, in differential form

$$\nabla \cdot \mathbf{D} = \rho \quad (2.6)$$

2.2 Solution of problems involving dielectric materials

Many problems in electrostatics deal with sets of electrodes together with dielectric materials. When the symmetry of a problem is simple it is possible to use Gauss' theorem in much the same way as in Chapter 1.

Figure 2.2 shows a coaxial cable in which the space between the conductors is filled with a dielectric material of permittivity ϵ . We wish to find an expression for the electric field within the dielectric when the potential difference between the electrodes is V_0 .

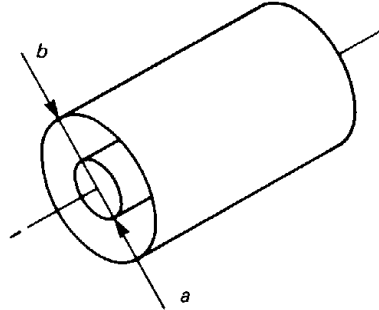

Fig. 2.2 The arrangement of coaxial cylindrical electrodes, an idealization of a coaxial cable.

Assume that the conductors carry charges $\pm q$ per unit length, with the inner conductor being positively charged. Applying Gauss' theorem as given in Equation (2.5) to a cylindrical Gaussian surface of radius r we find that the radial component of \mathbf{D} is given by

$$D_r = \frac{q}{2\pi r} \quad (2.7)$$

then, using Equation (2.4)

$$E_r = \frac{D_r}{\epsilon} = \frac{q}{2\pi\epsilon r} \quad (2.8)$$

The potential difference between the conductors is found by using Equation (1.13)

$$V_b - V_a = -\int_a^b E dr = -\int_a^b \frac{q}{2\pi r} dr = -V_0 \quad (2.9)$$

Then

$$V_0 = \frac{q}{2\pi\epsilon} \ln\left(\frac{b}{a}\right) \quad (2.10)$$

The charge q which was assumed for the purposes of the solution need not be calculated explicitly and can be eliminated to give the radial component of the electric field as a function of radial position:

$$E = \frac{V_0}{r \ln(b/a)} \quad (2.11)$$

2.3 Boundary conditions

When two or more dielectric materials are present it is necessary to treat each region separately and then to apply the appropriate **boundary conditions** at the interfaces. There are three of these conditions relating to V , E and D respectively.

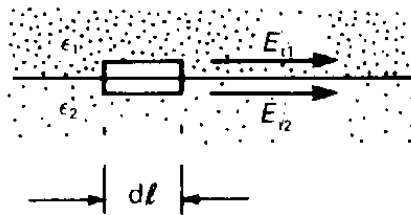

The *electrostatic potential is continuous at a boundary*, that is, it cannot change suddenly there. The physical reason for this condition is that an abrupt change in the potential would imply the presence of an infinitely strong electric field.





How to retain your top staff
FIND OUT NOW FOR FREE

DO YOU WANT TO KNOW:

-  What your staff really want?
-  The top issues troubling them?
-  How to make staff assessments work for you & them, painlessly?

Get your free trial

Because happy staff get more done



Click on the ad to read more

To find the boundary condition for the electric field we consider an infinitesimal closed path as shown in the figure on the right. The path is chosen so that it crosses the boundary between two dielectrics having permittivities ϵ_1 and ϵ_2 as shown. If the loop is made very thin, then the contributions to the line integral in Equation (1.16) arising from the parts of the loop normal to the boundary are negligible. If, in addition, the tangential components of the electric field are E_{t1} and E_{t2} , then the integral becomes

$$(E_{t1} - E_{t2})dl = 0$$

so that

$$E_{t1} = E_{t2} \quad (2.12)$$

This result can be stated in words as: *the tangential component of \mathbf{E} is continuous at a boundary.*

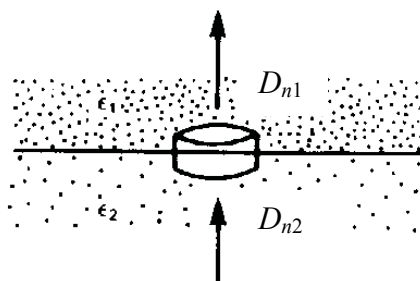

The boundary condition for the electric flux density can be found in a similar way by using Gauss' theorem. The figure in the margin shows a boundary between two dielectric materials with an infinitesimal Gaussian surface which crosses it. If the thickness of the 'pill box' is very small, then the contributions to the flux from the parts of the surface which are normal to the boundary are negligible and the integral becomes

$$(D_{n1} - D_{n2})dA = 0$$

where D_{n1} , and D_{n2} are the components of \mathbf{D} normal to the boundary on each side of it and dA is the area of the part of the boundary lying within the Gaussian surface. Thus

$$D_{n1} = D_{n2} \quad (2.13)$$

or, in words, *the normal component of \mathbf{D} is continuous at a boundary.*

To solve problems with two, or more, layers of dielectric material we first apply Gauss' theorem to find \mathbf{D} everywhere since that does not depend on the presence of the materials. Next Equation (2.4) is used to find \mathbf{E} in each region. Finally the potential difference across each layer is found using Equation (1.13).

2.4 Capacitance

Capacitors are very familiar as circuit elements, but it is not always realized that the idea of capacitance is more general. Capacitance exists between any pair of conductors which are electrically insulated from each other. Thus there is a capacitance between adjacent tracks on a printed circuit board, but this does not usually appear in the circuit diagram. This 'stray' or 'parasitic' capacitance can cause unwanted coupling between the parts of a circuit, causing it to oscillate or misbehave in some other way. Very few electronic engineers ever need to calculate the capacitance of a capacitor; they are much more likely to need to estimate the magnitude of a stray capacitance.

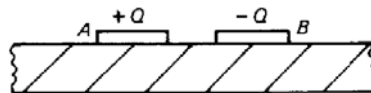

The figure on the right shows a cross-sectional view of two adjacent tracks on a printed circuit board. Let us suppose that the tracks are insulated from each other and from earth and that charge Q is transferred from B to A . Electrode B must then carry charge $-Q$. As a result of this transfer of charge, an electric field exists around the electrodes such that the potential difference between them is V .

If the dielectric material of the printed circuit board has a permittivity which does not vary with the electric field, then the system is linear and the principle of super-position may be applied. It follows that the potential difference between the electrodes is directly proportional to the charges on them, so we can write

$$Q = CV \quad (2.14)$$

where C is a constant of proportionality which is readily recognized as the capacitance between the electrodes familiar from elementary circuit theory. The unit of capacitance is the **farad** (F) and $1 \text{ F} = 1 \text{ C V}^{-1}$. Most capacitances are small and measured in microfarads, nanofarads or picofarads. Stray capacitances are usually of the order of picofarads.

2.5 Electrostatic screening

It has already been noted that unwanted capacitive coupling between electronic circuits can be a major problem. This is part of the larger problem of electromagnetic interference; another aspect, inductive coupling, is discussed in Chapter 6. The problem with all types of electromagnetic interference is how to minimize it rather than how to calculate its magnitude accurately. Electromagnetic theory provides the means for understanding the causes of electromagnetic interference and the techniques for dealing with them.

A simple case of the coupling of two circuits by stray capacitance is shown in Fig. 2.3. The circuits 1 and 2 are linked by the stray capacitance C_s and by a common earth. The stray capacitance is small, typically of the order of a pico-farad, so its impedance ($Z_s = 1/j\omega C_s$) is high, but decreases with increasing frequency. In this problem V_1 is the source of the interference picked up by circuit 2.

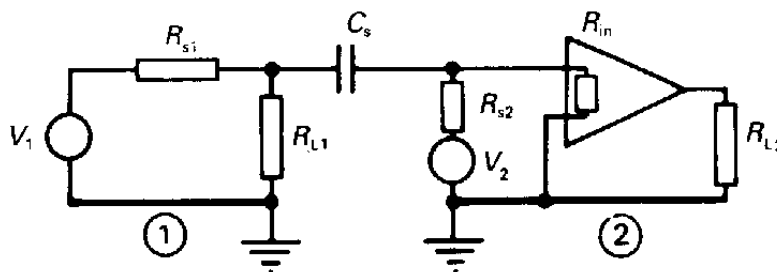

Fig. 2.3 Showing how two circuits can be coupled together by a stray capacitance C_s . The unwanted signal coupled from circuit 1 into circuit 2 can be large enough to be troublesome.

The current flowing through the capacitor is small compared with that in R_{L1} so the spurious signal appearing at the input of the amplifier is approximately

$$V_s = \left\{ \frac{R_{L1}}{R_{s1} + R_{L1}} \right\} \left\{ \frac{R'_h}{Z_s + R'_h} \right\} V_1 \tag{2.15}$$

Struggling to get interviews?

Professional CV consulting & writing assistance from leading job experts in the UK.

Visit site

Take a short-cut to your next job!
Improve your interview success rate by 70%.

TheCVagency
Visit theagency.co.uk for more info.

Click on the ad to read more

where $R'_{in} = (R_{s2} R_{in}) / (R_{s2} + R_{in})$. The spurious voltage given by Equation (2.15) is to be compared with the signal voltage at the input of the amplifier

$$V_{sig} = V_2 R'_n / (R_{s2} + R'_n)$$

Equation (2.15) shows that the spurious signal is greatest when the source impedance R_{s1} , is low and the effective input impedance of the second circuit R'_{in} is high. An indication of the order of magnitude of capacitance which can cause trouble can be obtained by supposing that circuit 1 is the a.c. main. R_{s1} is then very small. If R'_{in} is 1 MΩ and V_s is 1 μV, Z_s is approximately $2.4 \times 10^{14} \Omega$, which corresponds at 50 Hz to a stray capacitance of the order of 10^{-14} F.

The capacitive coupling between the circuits can be reduced by putting an earthed screen between them, as shown in Fig. 2.4. The stray capacitance is divided into two parts in series with each other and with their common point earthed. In practice, unless the screen completely encloses one of the circuits, there is still a residual capacitance connected directly between P and Q, bypassing the screen. Quite effective screening can be achieved with a partial enclosure provided that it intercepts most of the field lines passing from P to Q. It is essential that the screen is earthed, otherwise P is connected to Q by C_{s1} in series with C_{s2} , without a signal path to earth from their common point.

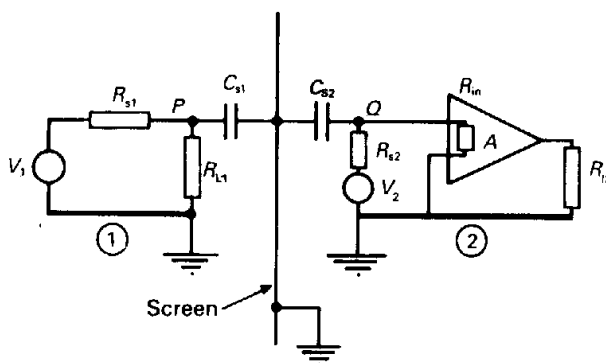

Fig. 2.4 The unwanted coupling between the two circuits illustrated in Fig. 2.3 can be greatly reduced by putting an earthed screen between them. Any current passing through C_{s1} is conducted to earth instead of passing through C_{s2} to Q.

When very good screening against low-frequency electric fields is required then a closed conducting box must be used. Since all the sources of the field lie outside the box and it must be an equipotential surface it follows that, theoretically, the electric field inside it is zero. Such a box is sometimes known as a ‘Faraday cage’. In practice, any enclosure will have one or more holes in it to allow wires to pass in and out and these may reduce the effectiveness of the screen. Similarly, the screening effectiveness is affected by the way in which the joints of the box are made.

The **electric screening effectiveness** of an enclosure is defined as the ratio of the magnitude of the electric field with the screen to that at the same point when the screen is removed. It is usually expressed in decibels. At high frequencies other factors come into play.

The effects of capacitive coupling can also be reduced by using a differential amplifier if the source V_2 can be isolated from earth. Figure 2.5 shows how this works. The stray capacitances C_{s1} and C_{s2} are often approximately equal and so the spurious signals appearing at the normal and inverting inputs of the amplifier are also very nearly the same. If the amplifier has a high common-mode rejection ratio, then only their difference is amplified and added to the wanted signal. Adding an earthed screen reduces the stray capacitive coupling and therefore reduces the unwanted signal still further. The source for circuit 2 may be a transducer situated some distance from the amplifier. In that case the connecting cables must be screened as well as the amplifier, a point which is discussed further in Chapter 6.

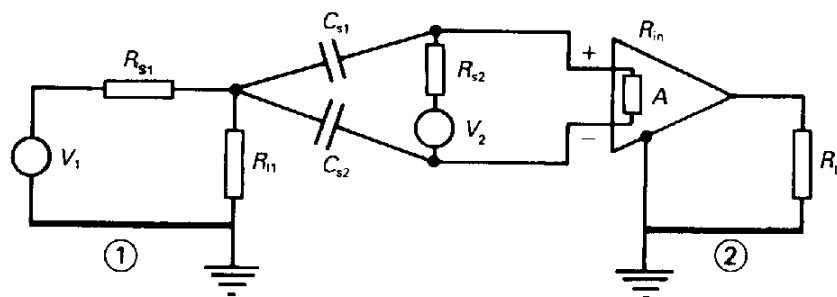

Fig. 2.5 When the input to a circuit can be isolated from earth it is possible to reduce capacitive coupling effects by using an amplifier with a differential input. The unwanted signals coupled through C_{s1} and C_{s2} are approximately equal but only their difference is added to the signal.

It is also possible for there to be capacitive coupling between the output and the input of an amplifier. When that happens there can be positive feedback causing the circuit to oscillate, so once again screening is needed.

2.6 Calculation of capacitance

In simple cases where the field problem can be solved by the direct application of Gauss' theorem it is straightforward to calculate the capacitance. The sequence of steps is:

1. Assume charges $\pm q$ on the conductors.
2. Apply Gauss' theorem, superposition or the method of images to find \mathbf{E} .
3. Integrate \mathbf{E} along any convenient path between the conductors to find the potential difference between them.
4. Calculate the capacitance from $C = q / V$.

When the shapes of the electrodes are more complicated than those in the examples above it is no longer possible to use the same method to calculate the capacitance. An alternative method is:

1. Assume potentials 0 and V on the electrodes.
2. Solve Laplace's equation analytically or numerically to give values of the potential everywhere.
3. Calculate \mathbf{E} close to the surface of one of the electrodes using $\mathbf{E} = -\text{grad } V$.
4. Calculate the surface charge density distribution on the electrode using $\sigma = \epsilon E$.
5. Integrate the charge density distribution over the surface of the electrode to give the total charge q .
6. Calculate the capacitance from $C = q / V$.

To summarize: capacitance can be obtained by calculating either

- a) The potential difference between the electrodes from assumed charges, or
- b) The charges on the electrodes from an assumed potential difference between them.

By using both approaches in an approximate way it is possible to obtain upper and lower bounds to the capacitance. The formal application of this in the energy method is described later in the chapter.

gaieteye
Challenge the way we run

**EXPERIENCE THE POWER OF
FULL ENGAGEMENT...**

.....

**RUN FASTER.
RUN LONGER..
RUN EASIER...**

**READ MORE & PRE-ORDER TODAY
WWW.GAITEYE.COM**

2.7 Energy storage in the electric field

When charge is transferred from one plate of a capacitor to the other work is done against the electric field. This work is stored as potential energy in the capacitor. It is easy to show that the stored energy is given by

$$W = \frac{1}{2}CV^2 = \frac{1}{2}\frac{Q^2}{C} = \frac{1}{2}QV \tag{2.16}$$

It is important to remember that Equation (2.16) applies to any pair of electrodes with a potential difference between them, not just to capacitors as lumped components.

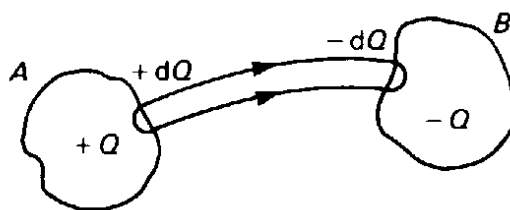
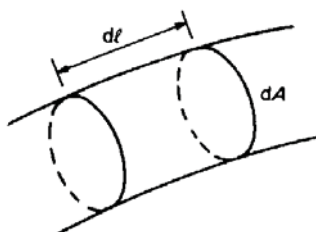

Fig. 2.6 The electric field between two charged conductors can be thought of as being made up of tubes of flux like the one shown. The walls of the tube are everywhere parallel to the local direction of the electric field. Its ends are terminated by equal and opposite charges.

It is sometimes useful to think of the energy stored in a capacitor as being distributed throughout the electric field associated with it. Figure 2.6 shows a capacitor with electrodes of arbitrary shape. We define a flux tube by considering a small element of the surface of the conductor *A* and following the lines of **E** which start from its boundary through space until they terminate upon *B*. Since the flux lines can never meet or cross each other it follows that the whole electric field of the capacitor can be divided up into flux tubes. In addition we observe that, if the charge on the element of *A* from which the tube starts is $+dQ$, then that on the element of *B* on which it ends must be $-dQ$ by a straightforward application of Gauss’ theorem to a Gaussian surface enclosing the tube.

The figure on the right shows a small part of the flux tube on a larger scale. A short length of the tube is chosen having length dl as shown, and the cross-sectional area of the tube at this point is dA . If the local electric field strength is E , then the potential difference between the ends of this element of volume is $dV = E dl$, where the dot product can be omitted because E and dl are parallel to each other by definition. Likewise, the relationship between the electric flux in the tube and the charges at its ends means that $dQ = D dA$.



The energy stored in the element of volume is then

$$dW = \frac{1}{2} dQ dV = \frac{1}{2} DE dl dA = \frac{1}{2} DE dv$$

using Equation (2.16) with the volume of the element represented by dv . In the limit as dv shrinks to zero the energy density in the electric field is $\frac{1}{2}DE$. A more rigorous derivation of this result which allowed for the possibility that the vectors \mathbf{D} and \mathbf{E} are not parallel to each other would show that the energy density in the field is given by

$$w = \frac{1}{2} \mathbf{D} \cdot \mathbf{E} \quad (2.17)$$

and the total energy stored in the field of the electrodes is

$$W = \frac{1}{2} \iiint \mathbf{D} \cdot \mathbf{E} dv \quad (2.18)$$

where the integral is taken over all that part of space in which the electric field is not zero.

2.8 Calculation of capacitance by energy methods

In many cases the solution required to a field problem is not detailed field information but a single number, the capacitance. The use of the concept of stored energy provides a particularly simple way to obtain estimates of capacitance without finding the exact solution to the field problem. The starting point is the fact that when a physical system is in stable equilibrium its stored energy is normally a minimum. From this it follows that any perturbation of the system must result in an increase in the stored energy.

Consider now two possible perturbations of the system of charges and electric fields in a capacitor. In the first case we retain the electrodes as equipotential surfaces but alter the charges on them in such a way that the equipotentials in the inter-electrode space assume particularly simple shapes. From these perturbed equipotentials we calculate the energy density in the field and, hence, the stored energy W' of the system. This energy must be greater than the stored energy W of the unperturbed system, so that

$$W' \geq \frac{1}{2} CV^2 \quad \text{or} \quad C \leq \frac{2W'}{V^2} \quad (2.19)$$

This provides an upper bound to the capacitance.

In the second case we hold the charges on the electrodes constant but redistribute them in such a way that the flux lines have a particularly simple form. When this is done the electrodes are no longer equipotential surfaces. Once again the stored energy, say W'' , is calculated, and this time

$$W'' \geq \frac{Q^2}{2C} \quad \text{or} \quad C \geq \frac{Q^2}{2W''} \quad (2.20)$$

giving a lower bound for the capacitance.

2.9 Finite element method

Many computer packages for the solution of field problems are based upon the use of finite elements. This technique is not suitable for hand calculation and the algorithm is a little complicated so only the principles of the method as applied to two-dimensional problems are described here.

In the finite element method the region between the electrodes is divided into a large number of triangular elements. Figure 2.7(a) shows one such element in the x - y plane. It can be shown that the condition that Laplace's equation should be obeyed inside the element is equivalent to the requirement that the energy stored within it should be a minimum. If the potential within the element is approximated by

$$V(x, y) = a + bx + cy \quad (2.21)$$

then the electric field components are

$$E_x = -b \quad \text{and} \quad E_y = -c \quad (2.22)$$

and the energy density is

$$w = \frac{1}{2} \epsilon_0 (b^2 + c^2) \quad (2.23)$$

This e-book
is made with
SetaPDF



SETASIGN



PDF components for PHP developers

www.setasign.com



Now the coefficients b and c can be expressed in terms of the positions of the vertices of the triangle and of the potentials at them. Thus the stored energy in the element can be expressed in terms of the same quantities.

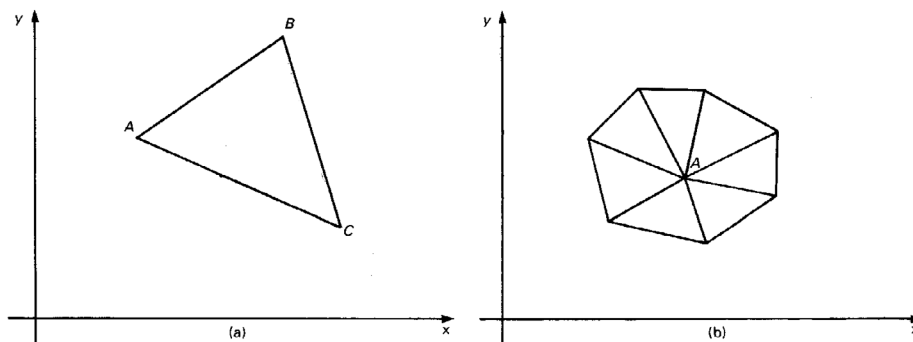

Fig. 2.7 The finite element method: (a) a single element and (b) a cluster of elements.

Now consider the cluster of triangular elements with a common vertex at A , as shown in Fig. 2.12(b). The energy stored in the cluster of elements, W , is the sum of the energies stored in each. We now select the value of the potential at A which minimises the stored energy by requiring that

$$\frac{\partial W}{\partial V_A} = 0 \quad (2.24)$$

The result is an equation giving the potential at A in terms of the potentials at the other vertices and their positions. It is interesting that, if triangular elements are formed from the square elements in Fig. 1.12 by adding diagonals from the lower left to the upper right corner of each square, then the application of the finite element method yields Equation (1.30).

The finite element method is important chiefly because of the freedom with which the sizes and shapes of the elements may be chosen. It is, therefore, possible to select a set of elements which fits the boundaries of the problem with good accuracy and which provides a concentration of small elements in regions where the potential is changing rapidly. In two-dimensional problems the spatial variation of the potential can be represented as a smooth surface. The finite element method approximates this surface by one with many small flat facets rather like the surface of a cut gem.

2.10 Boundary element method

The finite difference and finite element methods both depend upon the division of the space between the electrodes into a large number of small elements. The potential values at the nodes of the mesh are manipulated according to some algorithm until the solution has converged. The result of the process, in each case, is detailed information about the field at every point within the solution space. In large three-dimensional problems the number of variables can be very large indeed and the computation time correspondingly long.

Very often the result required from a field calculation is not the detailed field information but only a single number such as the capacitance. For problems of this kind an alternative method, the boundary element method, is useful because it only requires mesh points and potentials to be specified on the boundaries. This has the benefit that the number of variables in the solution is less than in the corresponding finite difference or finite element solution by two or three orders of magnitude. It also makes it easier to model problems with complicated boundaries. The fields at internal points can be calculated from the solution at the boundary if required.

2.11 Summary

Insulating materials are widely used in electronic engineering both to provide electrical isolation and to enhance the performance of capacitors. The dielectric qualities of most insulating materials can be represented by a constant, the permittivity. It is convenient to introduce a new field vector, the electric flux density D , whose value is independent of the presence of dielectric materials. The use of this vector makes the solution of problems involving dielectric materials easier. It is important to use the correct boundary conditions at the interfaces between different dielectric materials.

Capacitance occurs in capacitors and in stray capacitance between conductors. It can be calculated either by a direct solution of the field problem or by considering the stored energy in an approximation to the field associated with the capacitor. The latter method gives quite good accuracy with relative ease. Stray capacitances lead to unwanted coupling between electronic circuits. Techniques for reducing the coupling can be understood using the theory of electrostatics.

**YOU THINK.
YOU CAN WORK
AT RMB**

**RAND
MERCHANT
BANK**
A division of FirstRand Bank Limited
Traditional values. Innovative ideas.

Rand Merchant Bank uses good business to create a better world, which is one of the reasons that the country's top talent chooses to work at RMB. For more information visit us at www.rmb.co.za

Thinking that can change your world

Rand Merchant Bank is an Authorised Financial Services Provider



Click on the ad to read more

3 Steady electric currents

Objectives

- To introduce the ideas of current flow in electrical conductors and of electrical resistance.
- To show that Ohm's law is a special case of a more general relationship between current density and electric field.
- To derive expressions for the power dissipated per unit volume within a conductor.
- To show how the distribution of current within a conductor can be calculated.
- To introduce the continuity equation and to show how Kirchhoff's current law is a special case of it.
- To introduce the concept of the electromotive force of a source of electric power.
- To modify the equation for the line integral of the electric field around a closed path derived in Chapter 1 to allow for the presence of sources of electric power, and to show that the resulting equation is a generalization of Kirchhoff's voltage law.
- To show how the resistance of a conductor can be calculated directly, by the use of Laplace's equation, and by energy methods.

3.1 Conduction of electricity

In the preceding chapters we have studied problems involving charges which are at rest. This is convenient for the formal exposition of electromagnetic theory, but most people meet electrical phenomena for the first time in the form of electric currents flowing in wires. A current can flow in any medium in which there are charges which are free to move. These **conduction charges** may be electrons, positively charged 'holes', or positive or negative ions, according to the material. They are in continuous random motion, with a distribution of velocities which depends upon the temperature of the material. They are also constantly colliding with each other and with the atomic structure of the material.

When a conducting material is placed in an electric field the conduction charges are accelerated in the direction of the field. The velocity acquired is small compared with the average value of the random velocity at ordinary temperatures, and is superimposed on it. The ordered part of the motion would increase without limit were it not for the collisions which convert it into random motion. Overall, the effect of the field is to add a small average drift velocity to the random velocity. The magnitude of the drift velocity is related to the strength of the field by the equation

$$\mathbf{v}_d = \mu \mathbf{E} \quad (3.1)$$

where μ is known as the **mobility** of the charge carriers. The mobility depends on

1. the type of charge carrier;
2. the material in which it moves;
3. the temperature of the material.

It can also depend on

4. the strength of the electric field;
5. the orientation of the crystal axes to the field.

For many materials μ is a scalar quantity which varies only with temperature and this will be assumed here.

The rate of flow of electric charge across unit area of a plane normal to the direction of v_d is the **current density** given by

$$\mathbf{J} = nq\mathbf{v}_d \quad (3.2)$$

where n is the density of charge carriers and q the charge on each. Combining Equations (3.1) and (3.2) gives

$$\mathbf{J} = nq\mu\mathbf{E} = \sigma\mathbf{E} \text{ or } \mathbf{E} = \rho\mathbf{J} \quad (3.3)$$

where σ is the **conductivity** of the material, measured in siemens per metre. J is measured in coulombs per square metre per second or in amperes per square metre, defining the **ampere** as a current of one coulomb per second. It is sometimes convenient to use the reciprocal of conductivity which is known as **resistivity** (ρ). Resistivity is measured in V m A^{-1} or $\Omega \text{ m}$.

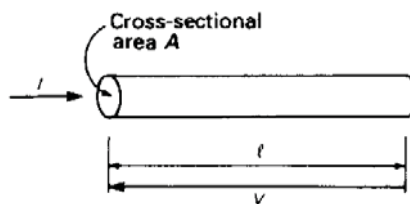

To link these ideas with those of elementary circuit theory consider the flow of electric current in a section of straight wire as shown in the figure on the right. If the wire has cross-sectional area A and carries a current I uniformly distributed across it, then the current density is

$$J = I/A \quad (3.4)$$

The relationship between the electric field in the wire, the potential difference between its ends, and its length is

$$E = V/l \quad (3.5)$$

But $E = \rho J$ from Equation (3.3) and therefore

$$V = \left(\frac{\rho l}{A} \right) I = RI \quad (3.6)$$

which is the familiar form of Ohm's law. Equation (3.3) is thus shown to be a general form of Ohm's law applicable to problems in which the current density is not uniform.

3.2 Ohmic heating

When conduction charges are accelerated by an electric field, they continually gain energy from it. This ordered kinetic energy is transferred to the bulk of the material by collisions, so increasing the random thermal motions of the atoms.

The conversion of electrical energy into heat is familiar from its everyday use in electric heaters and light bulbs. For a steady current I sustained by an applied voltage V the power input is

$$P = VI = I^2 R = V^2/R \quad (3.7)$$

an equation which is well known from elementary circuit theory. By using the results of the previous section we can find corresponding formulae for the details of the energy dissipation within a conducting material.

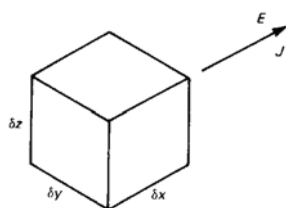

Consider the element of volume shown in the figure on the right. Provided that the properties of the material are the same in all directions, we can set the x -axis parallel to the direction of the current without loss of generality. The potential difference across the element is

$$V = E \delta x \quad (3.8)$$

and the current flowing through it is

$$I = J \delta y \delta z \quad (3.9)$$

Thus the power dissipated in the element is

$$\delta P = EJ \delta x \delta y \delta z = EJ \delta v = \sigma E^2 \delta v = \rho J^2 \delta v \quad (3.10)$$

where δv is the volume of the element. A more rigorous derivation would show that

$$\delta P = \mathbf{E} \cdot \mathbf{J} \delta v \quad (3.11)$$

This expression is valid even when the vectors \mathbf{E} and \mathbf{J} are not parallel to each other. Equation (3.10) shows that the power density is greatest in regions of high current density. This phenomenon is of great practical importance. In fuses the provision of a section of thin wire in a circuit ensures that that section is heated to melting point before any other part of the circuit is damaged. On the other hand, wiring joints which are carelessly designed or made can overheat and fail.



Discover the truth at www.deloitte.ca/careers

Deloitte.

© Deloitte & Touche LLP and affiliated entities.



Click on the ad to read more

3.3 The distribution of current density in conductors

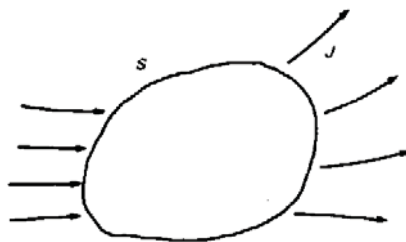

We would like to know how to calculate the variation of current density with position. To do this we consider the net current flow out of a closed surface S enclosing a volume V as shown in the figure on the right. If the current density in the region of S is \mathbf{J} (not necessarily a constant) then the net current flow out of S is given by the integral of the normal component of \mathbf{J} over S , that is

$$S = \oiint_S \mathbf{J} \cdot d\mathbf{A} \quad (3.12)$$

Now if there is a net current flow out of a closed surface, then the total charge enclosed by that surface must be changing with time because charges cannot be created or destroyed. Thus

$$\text{current out of } S = -\frac{\partial}{\partial t}(\text{charge enclosed by } S)$$

which may be written in mathematical notation as

$$\oiint_S \mathbf{J} \cdot d\mathbf{A} = -\frac{\partial}{\partial t} \iiint_V \rho \, dv \quad (3.13)$$

This is a mathematical statement of the **principle of conservation of charge**. Note that ρ is charge density, not resistivity, in this equation.

Using the same method as we used in Chapter 1 to get from Equation (1.5) to Equation (1.11), it is easy to show that the differential form of Equation (3.13) is

$$\nabla \cdot \mathbf{J} = -\frac{\partial \rho}{\partial t} \quad (3.14)$$

This equation, in either its integral or its differential form, is known as the **continuity equation**. It is valid for the flow of charges in a vacuum as well as in conducting materials.

When the current flow is in a steady state, the right-hand sides of Equations (3.13) and (3.14) are zero. If, furthermore, the conductivity of the material is constant, then

$$\nabla \cdot \mathbf{J} = \nabla \cdot (\sigma \mathbf{E}) = \sigma (\nabla \cdot \mathbf{E}) = 0 \quad (3.15)$$

since σ is a constant. But

$$\mathbf{E} = -\nabla V \tag{Equation (1.23)}$$

so that, from Equation (3.15)

$$\nabla \cdot (\nabla V) = \nabla^2 V = 0$$

Thus when a steady electric current flows in a material of constant conductivity the potential distribution obeys Laplace’s equation (Equation 1.27).

In the special case of currents flowing in wires, as shown in Fig. 3.1, the integral on the left-hand side of Equation (3.13) becomes the sum of the currents in the wires

$$I_1 + I_2 + I_3 + \dots + I_n = 0 \tag{3.16}$$

which is **Kirchhoff’s current law** familiar from electrical circuit theory. The continuity equation is therefore a generalization of Kirchhoff’s current law.

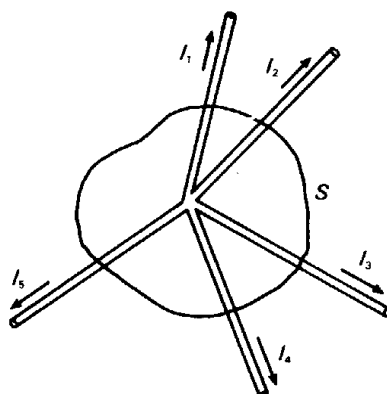
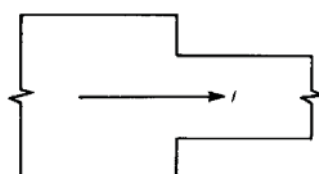

Fig.3.1 Applying the continuity equation to the special case of steady currents flowing in wires

In general, provided that the conductivity is constant, the current density distribution can be calculated from the solution of Laplace’s equation. The figure on the right shows a typical problem: a strip with a step change in its width. In this case Laplace’s equation would have to be solved by numerical methods. The potential is specified by assuming that at some distance from the step the equipotentials are straight lines perpendicular to the length of the strip. Along the sides there is a boundary between a conductor and an insulator. Since no current can cross this boundary the electric field must be tangential to the boundary.



3.4 Electric fields in the presence of currents

When electric currents flow through a system of conductors there is an electric field in the space around the conductors in addition to the field within the conductors which drives the current. As an example, consider the field around a coaxial line carrying equal and opposite currents in the core and the sheath, as shown in Fig. 3.2. Within the conductors the field lines, like the current flow lines, lie parallel to the axis. Outside them the field is modified from the purely radial electrostatic solution.

The finite resistance of the conductors requires that the potential at A should be higher than that at B and that at C should, likewise, be greater than that at D . There must, therefore, be axial components of the electric field in the space between the conductors as well as in the conductors themselves. The tangential component of the electric field is continuous at the boundary (Equation (2.12)) so the field lines are curved as shown and are no longer normal to the boundary.

**I WANT TO CHANGE DIRECTION,
AND THE WORLD.**

GOT-THE-ENERGY-TO-LEAD.COM

We believe that energy suppliers should be renewable, too. We are therefore looking for enthusiastic new colleagues with plenty of ideas who want to join RWE in changing the world. Visit us online to find out what we are offering and how we are working together to ensure the energy of the future.

RWE
The energy to lead

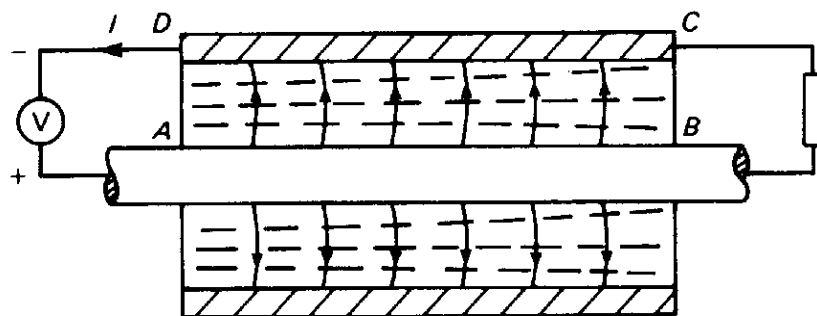

Fig. 3.2 Electric field lines and equipotential surfaces in a coaxial cable with resistive conductors.

3.5 Electromotive force

In this chapter we have assumed, so far, that sources of electric current exist, but we have paid no further attention to them. These sources have been represented as idealized voltage generators. In practice, they are most likely to be electrochemical cells or electromagnetic generators. The details of the inner workings of these sources do not fall within the scope of this book, but it is important to consider the effects of sources in the theory of electromagnetism.

We shall regard a source as a device capable of maintaining a potential difference and a steady flow of electric current between its terminals. Such a device is a source of electric power because it does work in driving the electric current around the circuit against the circuit resistance. As the charges move around the circuit from one terminal of the source to the other, they lose potential energy as it is converted into heat.

In Chapter 1 we saw that in an electrostatic field the line integral of the electric field around a closed path is zero

$$\oint \mathbf{E} \cdot d\mathbf{l} = 0 \tag{Equation (1.16)}$$

This equation remains true near a current-carrying circuit provided that the path of integration does not pass through the generator. But if the line integral of the electric field is evaluated around the circuit from one terminal of the source to the other, the result is not zero. This is because a net amount of work has to be done to move the charges along this path against the resistance of the circuit. The potential energy given up by a charge in this way is restored when it moves through the source. This can be expressed mathematically by writing

$$\int_C \mathbf{E} \cdot d\mathbf{l} = E \tag{3.17}$$

where E is the **electromotive force** (e.m.f.) of the source and the integral is taken around the circuit (C) from one terminal of the source to the other.

When the source is imperfect it is usual to equate the electromotive force with the **Thévenin voltage**, i.e. the open-circuit voltage of the source, and to include the source impedance in the external circuit.

For the special case of a circuit consisting of lumped components and generators joined by lossless conductors, the integral in Equation (3.17) becomes the sum of the potential differences across the components. The electromotive force is, likewise, the sum of the e.m.f.s of all the generators in the circuit. The result is **Kirchhoff's voltage law**:

$$R_1 I_1 + R_2 I_2 + \dots + R_n I_n = E_1 + E_2 + \dots + E_m \quad (3.18)$$

3.6 Calculation of resistance

From Ohm's law in the form

$$V = \left(\frac{\rho l}{A} \right) I = RI \quad (\text{Equation (3.6)})$$

it is clear that resistances can be calculated either by assuming a current and working out the potential difference, or by the opposite process. It is also possible to make use of energy methods, with the upper and lower bounds for the resistance being given by these two approaches. In simple cases the resistance of a conductor can be calculated directly using the expression in the brackets in Equation (3.6).

This approach is only of use in the relatively small number of cases where the shape of the conductor is such that either the current, or the potential, distribution is simple. This is clearly not the case with shapes such as that shown in Fig. 3.3. Problems of this kind can be solved by the following procedure:

1. Assume a value for the potential difference V between the ends of the strip;
2. Solve Laplace's equation with the appropriate boundary conditions;
3. Calculate the electric field and current density distributions on any convenient line across the strip using $E = -\nabla V$ and $J = \sigma E$;
4. Integrate J across the strip to find the total current I ;
5. $R = V/I$.

These steps can be carried out by numerical methods if necessary.

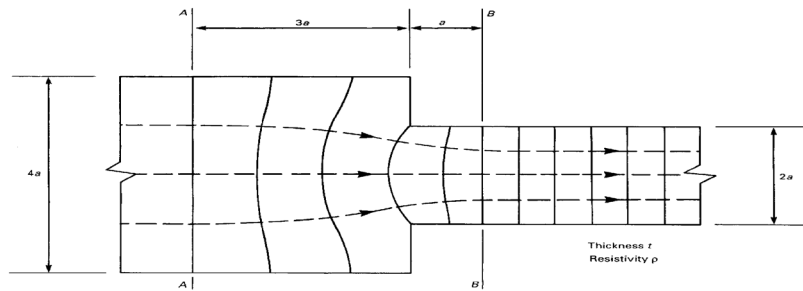

Fig. 3.3 Electric field lines (shown dashed) and equipotential surfaces for a current flowing through a conducting strip with a step change in width.

This method can sometimes be a bit tricky to apply because of the need to ensure that the normal component of \mathbf{E} is zero at the edge of the strip. We can sometimes get round the difficulty by using the **principle of duality**. In a field map such as Fig. 3.3 the field lines and the equipotentials are always at right angles to each other. We can therefore imagine a second problem whose field pattern is identical to the first except that the roles of the field lines and the equipotentials have been exchanged. Two problems related to each other in this way are called **duals** of each other. Sometimes it is easier to solve the dual of a problem and then to deduce the required answer from that solution.

bookboon.com

Corporate eLibrary

See our Business Solutions for employee learning

[Click here](#)

Management Time Management

Problem solving Self-Confidence Effectiveness

Project Management Goal setting Motivation Coaching



3.7 Calculation of resistance by energy methods

It has already been observed that capacitances can be calculated by energy methods to an accuracy which is adequate for many purposes. Similar methods can be used to calculate resistances. In this case it is assumed that the effect of perturbing the distribution of the electric field and the current density from equilibrium is to increase the rate of energy dissipation. Now the power dissipated in a resistance can be written as

$$W = I^2 R = V^2 / R \quad (\text{Equation (3.7)})$$

so, if the total current is given, and the power dissipated is calculated as W' from an approximate distribution of the current, then

$$W' \geq I^2 R \quad \text{so that} \quad R \leq W' / I^2 \quad (3.19)$$

giving an upper bound for the resistance. If, on the other hand, the potential difference across the resistance is given and the power W'' is calculated from an approximate set of equipotentials then

$$W'' \geq V^2 / R \quad \text{so that} \quad R \geq V^2 / W'' \quad (3.20)$$

giving a lower bound for R .

3.8 Summary

In this chapter we have explored the links between the theory of electromagnetism and the theory of electric circuits. It has been shown that Ohm's law and Kirchhoff's laws are special cases which arise when electromagnetic theory is applied to lumped components and to electrical networks.

On occasion it is necessary to calculate the resistance of a piece of conducting material. Three possible approaches have been discussed: direct calculation, the use of Laplace's equation and the use of energy methods. Direct calculation is possible only in a limited number of cases where the current density is uniform over surfaces of simple shape. The application of Laplace's equation can, in principle, solve all problems involving uniform conducting materials. Similar numerical methods can be used when the materials are not uniform. These methods are available as computer packages of great sophistication. For many purposes great accuracy is not required and then the energy methods are of value because of their ability to provide acceptable accuracy with little effort.

4 The magnetic effects of electric currents

Objectives

- To explain the relationship between magnetism and electricity.
- To introduce the Biot-Savart law and the magnetic circuit law and to show how they are used to calculate the magnetic flux density produced by electric currents.
- To introduce the concept of magnetic scalar potential and to discuss the types of problem in which it can be used.
- To show that forces are exerted on current-carrying conductors in magnetic fields.



Brain power

By 2020, wind could provide one-tenth of our planet's electricity needs. Already today, SKF's innovative know-how is crucial to running a large proportion of the world's wind turbines.

Up to 25 % of the generating costs relate to maintenance. These can be reduced dramatically thanks to our systems for on-line condition monitoring and automatic lubrication. We help make it more economical to create cleaner, cheaper energy out of thin air.

By sharing our experience, expertise, and creativity, industries can boost performance beyond expectations. Therefore we need the best employees who can meet this challenge!

The Power of Knowledge Engineering

Plug into The Power of Knowledge Engineering.
Visit us at www.skf.com/knowledge

SKF

4.1 The law of force between two moving charges

The theory of magnetism was developed independently from that of electricity until Oersted (1820) showed that the two subjects were linked. This link was later explored by Ampere, Faraday and Maxwell, but it was not until the theory of relativity was developed by Einstein that the relationship between them could be fully understood. It is now clear that magnetic effects can be regarded as a consequence of the motion of electric charges. It is not necessary to postulate the existence of magnetic poles or dipoles to explain experimental observations. The magnetic properties of materials, discussed in Chapter 5, can be explained by assuming the existence of circulating currents on the atomic scale. In this chapter we shall confine our attention to magnetic effects in free space.

The figure on the right shows two charges which have constant velocities v_1 and v_2 . It can be shown that the force exerted on Q_2 by Q_1 , is given by

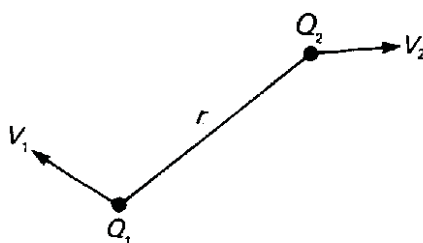

$$\mathbf{F} = \frac{Q_1 Q_2}{4\pi\epsilon_0 r^2} \hat{\mathbf{r}} + \frac{\mu_0 Q_1 Q_2}{4\pi r^2} (\mathbf{v}_2 \wedge (\mathbf{v}_1 \wedge \hat{\mathbf{r}})) = \mathbf{F}_e + \mathbf{F}_m \quad (4.1)$$

where $\hat{\mathbf{r}}$ is a unit vector pointing from 1 to 2 and the symbol \wedge represents the vector cross product. The first term in this equation is the electrostatic force (Equation (1.1)). The second term, which we shall recognize as the magnetic force, is a result of the motion of the particles. The constant μ_0 is known as the **primary magnetic constant**; it has the value $4\pi \times 10^{-7} \text{ H m}^{-1}$. (The Henry (H) is the unit of inductance – see Chapter 6).

It is instructive to compare the magnitudes of the two forces F_e and F_m . To simplify matters let us suppose that \mathbf{v}_1 is parallel to \mathbf{v}_2 . This gets rid of the vector products without affecting the order of magnitude of the result. The ratio of the magnitude of the magnetic force to that of the electrostatic force is then

$$\frac{F_e}{F_m} = \epsilon_0 \mu_0 v_1 v_2 = \frac{v_1 v_2}{c^2} \quad (4.2)$$

It can be shown that the constant c is the velocity of light (see Chapter 7), so c^2 has a numerical value which is approximately $10^{17} \text{ m}^2 \text{ s}^{-2}$. Thus the magnetic force is negligible compared with the electrostatic force unless either:

1. both particles have velocities close to that of light, or
2. the electrostatic component of the force is cancelled by the electrostatic force of an equal and opposite stationary charge.

The latter is just what happens when electrons are moving along conducting wires because those contain equal numbers of fixed positive charges. Although the electrons move at velocities much less than that of light, there are enormous numbers of them, so useful forces are produced. That is why magnetic forces can be used to generate electric power and to drive electric motors. Note that the cross product in Equation (4.1) means that the magnetic force on Q_2 is always at right angles to \mathbf{v}_2 .

4.2 Magnetic flux density

In the development of the theory of electrostatics in Chapter 1 the sources of electrostatic force were separated from their effects by introducing the concept of the electric field. Following the same approach, we introduce a new vector \mathbf{B} and split the magnetic term \mathbf{F}_m in Equation (4.1) into two parts:

$$\mathbf{B} = \frac{\mu_0 Q_1}{4\pi r^2} (\mathbf{v}_1 \wedge \hat{\mathbf{r}}) \quad (4.3)$$

and

$$\mathbf{F}_m = Q_2 (\mathbf{v}_2 \wedge \mathbf{B}) \quad (4.4)$$

The vector \mathbf{B} is referred to, somewhat confusingly, as the **magnetic flux density**. The units of \mathbf{B} are **tesla** (T) or **webers** per square metre (Wb m^{-2}). Equation (4.3) provides the basis for calculating the magnetic flux density produced by any combination of charges moving in free space. The effect of that flux density on any other charges can then be found by using Equation (4.4).

For the moment we will concentrate on ways of computing magnetic flux densities. This information might be needed to calculate:

- the forces on moving charges;
- the forces on current-carrying conductors;
- the forces on iron surfaces;
- self- and mutual inductances;
- induced voltages and currents;
- eddy current losses.

The second and third of these are mainly applied to electric machines, and we shall refer to them only briefly. The last two are dealt with in chapter 6.

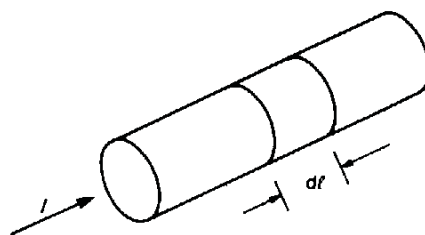

The source of the magnetic flux is often a current flowing in a wire, so another form of Equation (4.3) is needed. Consider an element of length dl in a wire carrying a current I as shown in the figure on the right. Let the current consist of charges of magnitude q moving with mean drift velocity v_d . If there are n charge carriers per unit volume and the cross-sectional area of the wire is A , then the current in the wire is given by $I = nqAv_d$ from Equation (3.2). But the charge contained in the element of wire is $nqAdl$, so that

$$Qv_d = (nqAdl)v_d = I dl \quad (4.5)$$

The contribution to the magnetic flux density from the charges within the element is therefore, from Equation (4.3),

$$d\mathbf{B} = \frac{\mu_0(nqAdl)}{4\pi r^2}(\mathbf{v}_d \wedge \hat{\mathbf{r}}) = \frac{\mu_0 I}{4\pi r^2}(\mathbf{dl} \wedge \hat{\mathbf{r}}) \quad (4.6)$$

where \mathbf{dl} is a vector element of length.

But isolated current elements cannot exist so Equation (4.6) must be integrated around the complete circuit in which the current is flowing. The result is

$$\mathbf{B} = \frac{\mu_0 I}{4\pi} \oint \frac{\mathbf{dl} \wedge \hat{\mathbf{r}}}{r^2} \quad (4.7)$$

With us you can
shape the future.
Every single day.

For more information go to:
www.eon-career.com

Your energy shapes the future.

e.on



This equation is known as the **Biot-Savart law**. It can be used to compute the magnetic flux density at any point produced by known currents flowing in a given arrangement of conductors. Since the flux density is proportional to the current such problems are linear and the principle of superposition can be used.

Figure 4.1 shows a short straight section of wire carrying a current I . To find an expression for the magnetic flux density at the point P at a perpendicular distance R from the wire we consider a small element of the wire of length dl .

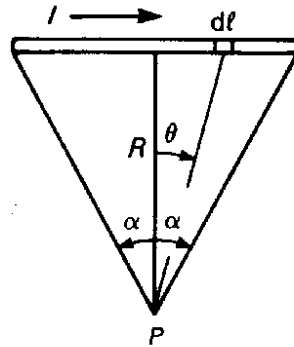

Fig. 4.1 Calculation of the magnetic flux density produced at the point P by a short length of wire carrying current I .

From Equation (4.6) the magnetic flux density at P produced by the element dl is

$$dB = \frac{\mu_0 I dl \cos \theta}{4\pi R^2 \sec^2 \theta} \quad (4.8)$$

But

$$dl = d(R \tan \theta) = R \sec^2 \theta d\theta$$

so, substituting for dl in Equation (4.8),

$$dB = \frac{\mu_0 I \cos \theta d\theta}{4\pi R}$$

The magnitude of the flux density at P produced by the whole wire is found by integrating over the length of the wire

$$B = \frac{\mu_0 I}{4\pi R} \int_{-\alpha}^{\alpha} \cos \theta d\theta = \frac{\mu_0 I \sin \alpha}{2\pi R} \quad (4.9)$$

Examination of the vector cross product in Equation (4.6) shows that \mathbf{B} is perpendicular to both R and to the wire, and that it is directed into the paper.

4.3 The magnetic circuit law

A useful method for calculating the magnetic flux density can be derived by considering the line integral of the vector \mathbf{B} around a closed path. Figure 4.2 shows such a path encircling a long straight wire carrying current I . The return wire for the current is assumed to be far enough away for it to have no appreciable field anywhere on the path. The flux density at any point on the path can be calculated from the Biot-Savart law by allowing α to tend to $\pi/2$ in Equation (4.9), with the result $B = \mu_0 I / 2\pi R$.

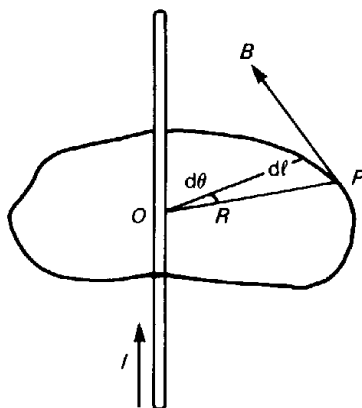

Fig. 4.2 A general path of integration around a long straight wire.

From symmetry, the vector \mathbf{B} must be perpendicular to the wire and to the line OP . For a small movement dl along the path the contribution to the line integral is

$$\mathbf{B} \cdot d\mathbf{l} = BR d\theta = \frac{\mu_0 I}{2\pi} d\theta \tag{4.10}$$

This expression is independent of the radius and so, for any closed path encircling the wire,

$$\oint \mathbf{B} \cdot d\mathbf{l} = \mu_0 I \tag{4.11}$$

This result is known as the **magnetic circuit law**. It may be stated in words as follows: *The line integral of the vector \mathbf{B} around a closed path is equal to μ_0 times the total current enclosed.* This form of the law is derived from Equation (4.11) by using the principle of superposition. An equation in the form of (4.11) is written for the magnetic flux density due to each conductor and then the set of equations is summed. The result remains true when the current is distributed as a current density rather than being confined in a set of wires.

The general form of the law can be written

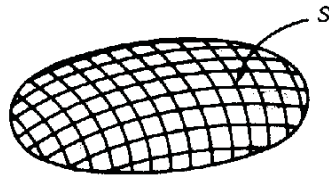

$$\oint \mathbf{B} \cdot d\mathbf{l} = \mu_0 \iint \mathbf{J} \cdot d\mathbf{A} \tag{4.12}$$

where the normal component of the current density \mathbf{J} is integrated over an open surface S which spans the closed curve as illustrated by the figure on the right. This equation, like Gauss' theorem in electrostatics, can be applied usefully to problems only when it is possible to deduce the distribution of the magnetic flux density from the symmetry of the problem. We shall see in Chapter 5 that it has a very important use in the solution of problems in which the greater part of the magnetic flux is carried by an iron circuit.

© 2013 Accenture. All rights reserved.

be > your degree

Bring your talent and passion to a global organization at the forefront of business, technology and innovation. Discover how great you can be.

Visit accenture.com/bookboon

Be greater than.
consulting | technology | outsourcing

accenture
High performance. Delivered.



4.4 Magnetic scalar potential

Although the theory of magnetism has been developed here without using the idea of magnetic poles, it is useful to introduce the magnetic analogue of electric potential. This concept is a convenient mathematical device which does not have any physical significance. The magnetic scalar potential difference between the points P and Q , by analogy with Equation (1.13), is

$$V_Q - V_P = -\frac{1}{\mu_0} \int_P^Q \mathbf{B} \cdot d\mathbf{l} \tag{4.13}$$

where the constant μ_0 has been introduced so that Equation (4.13) has the same form as the equations given in older texts which assume the existence of magnetic poles.

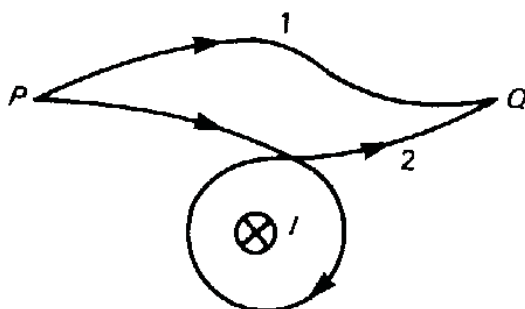

The magnetic scalar potential is of limited usefulness because it can be given a unique value only in a region of space in which there are no electric currents. This point is illustrated by the figure on the right. It can be shown from Equation (4.10) that the difference in the scalar potential between P and Q is independent of the path of integration chosen provided that it does not encircle any electric current. If, however, a path such as 2 were chosen for the integration, the result would be to subtract I from the value of the potential difference calculated.

What is worse still is that, by making several loops around the current, it is possible to make the potential difference take a whole series of different values, because the value of the integral changes by I for each complete loop made around the current. Thus the magnetic scalar potential can be given a unique value only in a region of space containing no currents. Despite this limitation there are still times when the idea is useful.

The differential form of Equation (4.13) is

$$\mathbf{B} = -\mu_0 \text{grad } V = -\mu_0 \nabla V \tag{4.14}$$

Moreover, since it has been assumed that free magnetic poles do not exist, the magnetic analogue of Gauss' theorem is

$$\oiint \mathbf{B} \cdot d\mathbf{A} = 0 \quad (4.15)$$

or, in words, *the flux of \mathbf{B} out of a closed surface is zero*. The unit of magnetic flux is the **weber** (Wb). The differential form of Equation (4.15) is

$$\operatorname{div} \mathbf{B} = \nabla \cdot \mathbf{B} = 0 \quad (4.16)$$

Combining Equations (4.14) and (4.16), we find that V must obey Laplace's equation in free space just as the electric potential does. That is

$$\operatorname{div}(\operatorname{grad} V) = \nabla^2 V = 0 \quad (4.17)$$

The commonest use of the magnetic scalar potential is for calculating the magnetic flux density in the space between iron pole pieces. We shall return to this subject in Chapter 5.

4.5 Forces on current-carrying conductors

We have already seen that an element of a current-carrying conductor can be regarded as equivalent to a moving charge. Substitution from Equation (4.5) into Equation (4.4) gives the force on a current element as

$$\mathbf{F} = I(d\mathbf{l} \wedge \mathbf{B}) \quad (4.18)$$

The total force on a circuit carrying an electric current can be found by integrating Equation (4.18) over all the current elements in the circuit. This is of central importance in electric power engineering but rarely needed in electronics. You should consult other texts for details of its application.

4.6 Summary

The law of force between two electric charges moving with constant velocities differs from the electrostatic law of force by the presence of an additional term. This additional component of force is the magnetic force. Magnetism is thus shown to be a particular aspect of electricity rather than a separate phenomenon. The concept of magnetic flux density is a useful tool for calculating the magnetic forces on charges and currents. There are two ways of calculating the magnetic flux density produced by electric currents: the Biot-Savart law; and the magnetic circuit law.

The concept of scalar potential, which is useful in electrostatics, is found to be less useful in magnetostatics. It can be given a unique definition only in a region of space which is free from current-carrying conductors. The main application of the magnetic scalar potential is in calculating the magnetic flux density distribution in air gaps in magnetic circuits. The question of the magnetic force on a current-carrying conductor has been touched on only briefly because of its relative lack of importance in electronics.



"I studied English for 16 years but...
...I finally learned to speak it in just six lessons"
Jane, Chinese architect

ENGLISH OUT THERE

Click to hear me talking before and after my unique course download

5 The magnetic effects of iron

Objectives

- To show that the polarization of iron in a magnetic field can be represented by an equivalent surface current.
- To introduce the magnetic field vector \mathbf{H} as a means of calculating magnetic fields in the presence of iron without needing to calculate the equivalent surface current distribution.
- To introduce a revised form of the magnetic circuit law which is valid in the presence of magnetic materials.
- To derive the boundary conditions at the interface between two materials with different magnetic properties.
- To show that iron can be regarded as a conductor of magnetic flux and to consider the application of the idea to magnetic screening.
- To discuss the calculation of fields produced by current-carrying conductors in the presence of iron by the method of images.
- To apply the analogy between electric current and magnetic flux to magnetic circuits, introducing the concepts of magnetomotive force and reluctance.
- To consider approximate ways of dealing with fringing and leakage fluxes in magnetic circuits.
- To discuss the description of the properties of a magnetic material by its hysteresis loop, including the concepts of remanence and coercive force and the distinction between hard and soft magnetic materials.
- To consider the solution of magnetic circuit problems when non-linear effects are important.
- To consider the solution of magnetic circuit problems involving permanent magnets, including questions of the stabilization of the magnets and Evershed's criterion for optimizing the design of a circuit.

5.1 Introduction

All engineering students must, at some time, have played with magnets and been fascinated by their ability to pick up, not just single iron objects, but whole strings of pins or paperclips. The strange property of iron and one or two other materials, which we call ferromagnetism, is employed in many ways in electronics.

- The ability of ferromagnetic materials to concentrate and conduct magnetic flux is used in inductors and recording heads.
- Permanent magnets find application in loudspeakers.
- Special high-resistivity materials known as ferrites are used to make aerials, inductors for radios and microwave components such as circulators and isolators.
- Magnetic media are used for recording purposes in the form of audio and video tapes and computer disks though this is less important than it used to be.
- The most important uses of ferromagnetic materials, if sheer weight of material were to be the criterion, are in electrical power engineering, in transformers, generators and motors. These lie outside the scope of this book, but they are important examples of the application of the fundamental ideas in electromagnetism discussed in this chapter.

5.2 Ferromagnetic materials

The overwhelming majority of materials which exist in the world have magnetic properties which differ so little from those of a vacuum that, for nearly all engineering purposes, they are indistinguishable from it. The exceptions to this rule are the elements iron, cobalt and nickel, together with certain materials which include them. Their special properties are illustrated by Fig. 5.1.

Figure 5.1(a) shows an air-cored solenoid carrying a current I . The flux density in the vicinity of the solenoid, somewhat as shown, could be mapped with the aid of a flux meter. It is worth emphasizing that there would be no measurable change in the field if the solenoid were filled with a core made of brass, aluminium, wood, plastic, or any other non-ferromagnetic materials. If, on the other hand, an iron core were inserted the result would be a considerable increase in the flux density, as shown in Fig. 5.1(b).

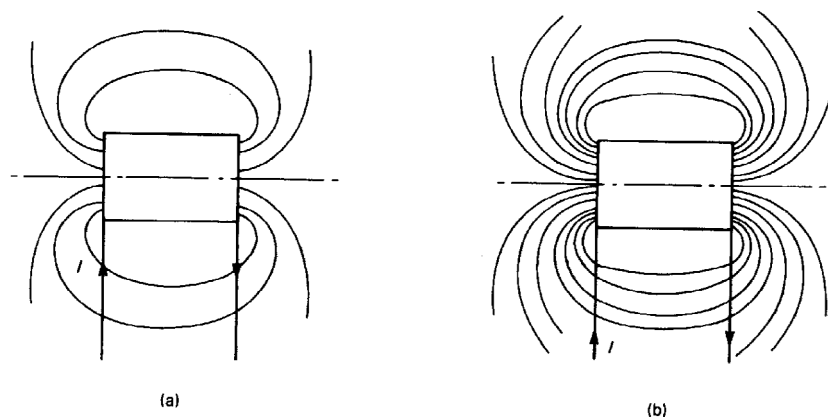
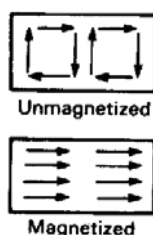

Fig. 5.1 The magnetic fields of (a) an air-cored solenoid and (b) a similar solenoid with an iron core, showing diagrammatically the great increase in the strength of the field in the second case.

This property of iron arises because the iron atoms are themselves tiny permanent sources of magnetic flux like current loops. If each of these 'loops' is represented by an arrow to show its polarity, then a qualitative explanation of ferromagnetism can be given. In an un-magnetized piece of iron the atomic magnets are arranged, head to tail, in closed loops. All the flux then circulates within the iron and none of it outside. The effect of applying an external flux density to the iron is to cause the atomic magnets to line up with the external flux so that their flux is added to it. These two situations are illustrated diagrammatically in the figures on the right. The actual processes of magnetization are more complex than this, but there is no room in this book to enter into them in more detail. The macroscopic phenomena of ferromagnetism are discussed later in this chapter.



From Fig. 5.1(b) we observe that the field outside the solenoid could just as well be produced by the addition of a second winding, with a suitable current and distribution of turns, to the air-cored solenoid of Fig. 5.1(a). This suggests that, just as the polarization of dielectric materials can be represented by a surface-charge distribution, so the polarization of ferromagnetic materials can be represented by a surface-current distribution. This is consistent with the view adopted in this book that magnetic phenomena are best regarded as resulting from the motion of electric charges.

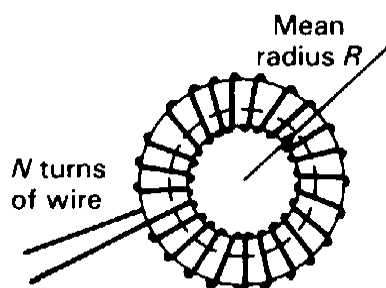

Fig. 5.2 An iron ring of mean radius R with N turns of wire wound uniformly upon it.

To illustrate the effect of the magnetization of iron we consider an iron ring with N turns of wire wound uniformly upon it as shown in Fig. 5.2. Let the current in the winding be I , and let the magnetization of the iron be represented by an additional current I' in the winding. Then, by the magnetic circuit law (Equation (4.11)) the flux density in the ring is obtained from

$$2\pi RB = \mu_0 N(I + I') \quad (5.1)$$

or

$$B = \frac{N}{2\pi R} \mu_0 (I + I') \quad (5.2)$$

Now experiments with electromagnets show that the magnetic flux density produced increases with the current, though not necessarily in a linear fashion, so let us assume that $I' = \chi_m I$ where χ_m is the **magnetic susceptibility**.

Then

$$B = \frac{N}{2\pi R} \mu_0 I (1 + \chi_m) \quad (5.3)$$

or, if $\mu_r = 1 + \chi_m$,

$$B = \frac{N}{2\pi R} \mu_0 \mu_r I = \frac{N}{2\pi R} \mu I \quad (5.4)$$

where the quantities μ and μ_r are known as the **permeability** and the **relative permeability** of the iron, respectively. The analogy with the case of dielectric permittivity is only superficial because it is hardly ever valid to regard the magnetic permeability as a constant, The other distinguishing feature is that the relative permeability of iron is much greater than the relative permittivity of common materials, being of the order of 10^4 .

DUKE
THE FUQUA
SCHOOL
OF BUSINESS

BUSINESS HAPPENS
HERE.

www.fuqua.duke.edu/globalmba

Learn More >



In problems involving dielectric materials we found it useful to make use of the vector \mathbf{D} to avoid having to calculate the distribution of polarization charges. The same approach can be used in magnetic problems. We define a new vector \mathbf{H} by the equation

$$\mathbf{H} = \frac{\mathbf{B}}{\mu} \quad (5.5)$$

so that, for the simple case shown in Fig. 5.2, we have

$$H = \frac{NI}{2\pi R} \quad (5.6)$$

The vector \mathbf{H} is known as the **magnetic field**. It is measured in A m^{-1} in SI units, as can be seen from Equation (5.6). Since the strength of the field is proportional to the product of the current in the winding and the number of turns, it is common to speak of a field strength of so many ‘ampere-turns per metre’. Equation (5.6) also shows that the vector \mathbf{H} depends only upon the distribution of electric currents and not upon the arrangement of any iron present.

Making use of the vector \mathbf{H} , we can deduce a form of the magnetic circuit law (Equation (4.12)) which is valid when magnetic materials are present:

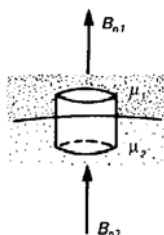

$$\oint \mathbf{H} \cdot d\mathbf{l} = \iint \mathbf{J} \cdot d\mathbf{A} \quad (5.7)$$

To find the distribution of magnetic flux density in problems involving iron we first calculate \mathbf{H} from the known distribution of currents, using Equation (5.7), and then calculate \mathbf{B} in each region from Equation (5.5).

Magnetic problems cannot usually be solved by the application of potential theory and the use of Laplace’s equation because of the non-linearity of magnetic materials. For the same reason it is not possible to make use of the principle of superposition unless linearizing assumptions can be made. This contrasts with the situation in electrostatics where the distribution of charges is frequently unknown but the potentials are given on the conducting boundaries.

5.3 Boundary conditions

Whenever a magnetic problem involves two or more regions of space with different magnetic properties it is necessary to use the relationships between the magnetic vectors on the two sides of each boundary.

The figure on the right shows the boundary between two materials having permeabilities μ_1 and μ_2 . Consider a Gaussian surface in the form of a 'pillbox' as shown. If the cross-sectional area of the box in the plane of the surface is dA , then the flux of \mathbf{B} out of the box is

$$(B_{n1} - B_{n2})dA = 0 \quad (5.8)$$

from Equation (4.15), since the contribution of the flux through the sides of the box becomes negligible as the height of the box tends to zero. The consequence of Equation (5.8) may be stated in words: *The normal component of \mathbf{B} is continuous across a boundary.*

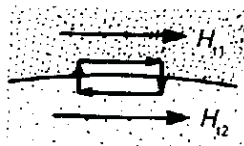

The boundary condition on \mathbf{H} is found by applying the magnetic circuit law to a small closed path encircling part of the boundary as shown in the figure on the right. If the length of the path parallel to the boundary is dl , then the line integral of \mathbf{H} around it becomes

$$(H_{t1} - H_{t2})dl = \text{current enclosed} \quad (5.9)$$

It should be noted that the current referred to is an actual electric current. It does not include the hypothetical surface currents which were introduced as a convenient way of describing magnetic materials. In many cases the surface current will be zero and then the boundary condition is that the *tangential component of \mathbf{H} is continuous across the boundary.*

5.4 Flux conduction and magnetic screening

Equation (5.9) has one very important practical corollary. Consider an iron bar surrounded by air. Assuming that there is no surface current flowing along the bar, we know that the tangential components of \mathbf{H} are equal inside and outside the bar. But, since $\mathbf{B} = \mu\mathbf{H}$, the component of the magnetic flux density parallel to the bar is much greater inside it than outside it.

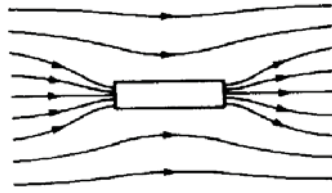

If such a bar is placed in a magnetic field in which the total flux is fixed, with the axis of the bar aligned with the field, then the requirement that $B_{\text{iron}} \gg B_{\text{air}}$ means that most of the flux will pass through the iron as shown in the figure on the right. The flux density in the air is then much less than it was before the iron was introduced. The iron therefore acts as quite a good conductor of magnetic flux.

The analogy between flux conduction by iron and electric conduction is strengthened still further if we consider what happens to the direction of a flux line entering the iron from the air, as shown in Fig. 5.3. The boundary conditions require that $B_{\text{ni}} = B_{\text{na}}$ and that $B_{\text{ti}} = \mu_r B_{\text{ta}}$. Now μ_r is typically in the range 10^3 – 10^6 , so the flux line must turn through an angle even greater than that indicated in Fig. 5.3. The angle of incidence is greatest when the flux line within the iron lies nearly parallel to the surface. A simple calculation shows that if $\alpha_i = 89^\circ$ and $\mu_r = 1000$, then $\alpha_a = 3.3^\circ$. For many purposes it is adequate to make the approximation that iron is a perfect magnetic conductor, so that all the flux lines enter it at right angles to the surface.

Join American online LIGS University!

Interactive Online programs
BBA, MBA, MSc, DBA and PhD

Special Christmas offer:

- ▶ enroll **by December 18th, 2014**
- ▶ **start studying and paying only in 2015**
- ▶ **save up to \$ 1,200** on the tuition!
- ▶ Interactive Online education
- ▶ visit ligsuniversity.com to find out more!

Note: LIGS University is not accredited by any nationally recognized accrediting agency listed by the US Secretary of Education. More info [here](#).



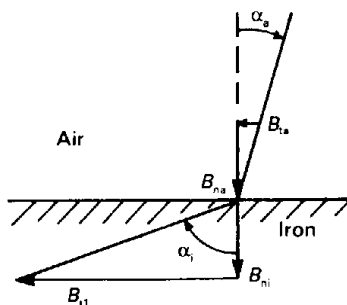

Fig. 5.3 The change in direction of a magnetic flux line when passing from air into iron.

The ability of iron to conduct flux is put to work in a number of ways. It allows magnetic circuits to be constructed which conduct the flux wherever it is required – an idea which we shall consider in detail later on. It also allows flux to be excluded from regions where it is not required. Figure 5.4 shows what happens when a hollow iron cylinder is placed in a magnetic field. The flux lines prefer to pass through the iron and the space within the cylinder is almost entirely free from magnetic flux. This property can be used to shield sensitive equipment from magnetic fields, and special alloys such as mumetal are used for this purpose.

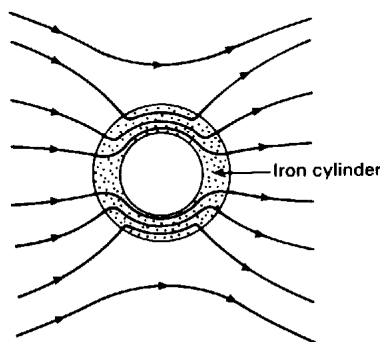

Fig. 5.4 An iron cylinder acts as a conductor of magnetic flux and screens the volume inside it from the external flux.

The effectiveness of a screen can be expressed in decibels as

$$S_M = 20 \log_{10} \left(\frac{\mathbf{B} \text{ at a point in the absence of the screen}}{\mathbf{B} \text{ at the same point with the screen}} \right) \tag{5.10}$$

A mumetal cylinder 100 mm in diameter and 1 mm thick has a magnetic screening effectiveness of 60dB provided that the external magnetic field is not strong enough to saturate it. It should be noted that it is only low-frequency fields which are screened out by the mechanism of flux conduction. A different mechanism operates at radio frequencies.

The fact that iron acts as a good conductor of flux means that it is often possible to calculate the distribution of flux around iron pole pieces by regarding them as equipotential surfaces and solving Laplace’s equation (4.17). This method can only give relative values of the flux density because the potentials of the pole faces are not known. The absolute values can be found by using the fact that the flux crossing the air gap is equal to that in the iron, apart from any leakage flux, and applying the magnetic circuit law to the whole flux path. The application of the magnetic circuit law to problems of this type is discussed in the next section.

The fact that an iron surface can be regarded as a magnetic equipotential surface allows the method of images to be used for the solution of problems in magnetostatics.

5.5 Magnetic circuits

The analogy between the conduction of electricity by conductors and the conduction of magnetic flux by iron leads us to the useful concept of a magnetic circuit. Figure 5.5 shows a simple magnetic circuit formed by a square iron core with a narrow air gap in it at A. A coil of N turns of wire is wound on the core and carries current I . To make the problem easy to handle we make some simplifying assumptions. Let us suppose that the magnetic field strength is the same everywhere within the iron, having the value H_i , and that the magnetic field in the air gap is H_a .

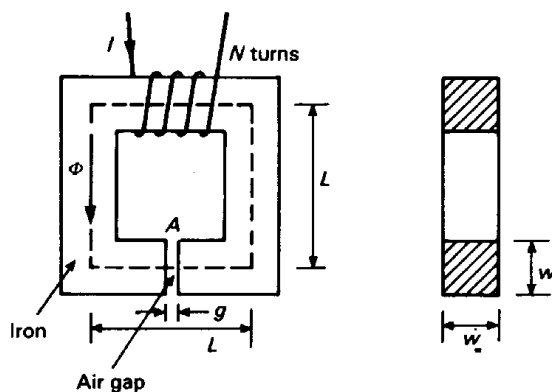

Fig. 5.5 A simple magnetic circuit made up of an iron core with an air gap in it. The flux is supplied by a winding of N turns of wire.

Now consider a closed path around the circuit which follows the centre line (shown dotted). Applying the magnetic circuit law to this path gives

$$4LH_i + gH_a = NI \tag{5.11}$$

Strictly speaking, the length of the iron path is $(4L - g)$ but, provided that g is small, the difference is negligible given the other assumptions which have been made.

The boundary condition (5.8) requires that

$$B_i = B_a = \frac{\Phi}{A} \quad (5.12)$$

where Φ is the total flux circulating, and A is the cross-sectional area of the iron at right angles to the direction of the magnetic field. We have therefore assumed that all the flux due to the coil is contained within the bounds of the iron core and its projection across the air gap. We also know from Equation (5.5) that

$$B_i = \mu H_i \quad \text{and} \quad B_a = \mu_0 H_a \quad (5.13)$$

Substitution for H_i and H_a in Equation (5.11) in terms of Φ and the various constants gives

$$NI = \frac{1}{A} \left(\frac{4L}{\mu} + \frac{g}{\mu_0} \right) \Phi \quad (5.14)$$

which can be written

$$\mathcal{M} = \mathcal{R} \Phi \quad (5.15)$$

where \mathcal{M} ($= NI$) is known as the **magneto-motive** force and \mathcal{R} as the **reluctance**.

ie business school

#1 EUROPEAN BUSINESS SCHOOL
FINANCIAL TIMES 2013

#gobeyond

MASTER IN MANAGEMENT

Because achieving your dreams is your greatest challenge. IE Business School's Master in Management taught in English, Spanish or bilingually, trains young high performance professionals at the beginning of their career through an innovative and stimulating program that will help them reach their full potential.

- Choose your area of specialization.
- Customize your master through the different options offered.
- Global Immersion Weeks in locations such as Rio de Janeiro, Shanghai or San Francisco.

Because you change, we change with you.

www.ie.edu/master-management | mim.admissions@ie.edu | f t in YouTube U

Equation (5.15) is analogous to Ohm's law for electric circuits, but the analogy must not be pressed too far. Unlike an electric current, the magnetic flux in the circuit dissipates no energy and there are no circulating magnetic charges. Moreover, it cannot be emphasized too often that magnetic materials do not normally behave in a linear fashion, so the reluctance of a circuit can only be regarded as approximately constant at best, and that only under a limited range of conditions. We will return to give this point further consideration after discussing the behaviour of real magnetic materials. First, though, it is useful to mention two other matters: fringing and leakage of magnetic flux.

5.6 Fringing and leakage

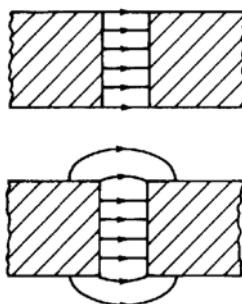

In the discussion of magnetic circuits above it was assumed that the flux lines in the air gap passed straight across, as shown in the upper figure on the right. A little thought shows that this is an oversimplification and that the flux lines must actually spread out into a **fringing field**, as shown in the lower figure in the margin. The truth of this observation can be demonstrated by laying a sheet of paper over the air gap and sprinkling iron filings on it. Clearly the reluctance of the magnetic circuit is affected by the fringing of the field around the gap so we need an estimate of how big the effect is.

A detailed solution of the problem would require the solution of Laplace's equation in the air gap (assuming the iron surfaces to be equipotentials). This is unnecessarily complicated for most purposes. A useful rule of thumb is that the effective cross-sectional area of the air gap is larger than that of the pole face by a strip of width $g/2$ around it, as shown in Fig. 5.6. Equation (5.12) then becomes

$$\Phi = B_i w^2 = B_a (w + g)^2 \quad (5.16)$$

and the reluctance of the circuit is

$$\mathcal{R} = \left(\frac{4L}{\mu w^2} + \frac{g}{\mu_0 (w + g)^2} \right) \quad (5.17)$$

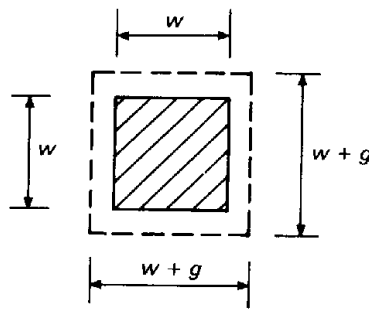

Fig. 5.6 The fringing of the magnetic field in an air gap can be allowed for, approximately, by adding an extra strip around the area of the pole face.

Fringing fields are put to use in magnetic recording heads. Figure 5.7 shows a typical arrangement. Most of the flux in the magnetic circuit passes directly across the air gap, but some of the fringing field passes through the magnetic coating on the tape and magnetizes it. To achieve linear performance the signal supplied to the coil is superimposed on an a.c. bias current whose frequency is at least five times the maximum signal frequency.

The tape is replayed by passing it across either the same head or a similar read head where the varying magnetization of the tape produces a varying flux in the magnetic circuit. We shall see in Chapter 6 that varying the flux passing through a coil causes an electromotive force to be induced in it. The e.m.f. can be processed to recover the original signal waveform.

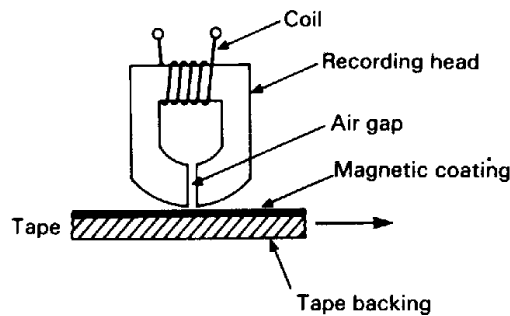

Fig. 5.7 The arrangement of a magnetic recording head.

A second difficulty in calculating the flux in the air gap is illustrated by Fig. 5.8. Some of the flux simply takes a short cut such as A-A' and never reaches the gap at all. This flux is known as **leakage flux**. It exists because, although iron conducts flux better than air, the air is a poor magnetic insulator.

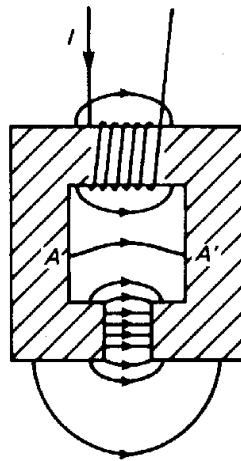

Fig. 5.8 An electromagnet showing a typical flux leakage path $A-A'$.

If we wish to pursue the analogy with electric circuits it is necessary to think of the material surrounding the conductor as being a poor conductor (such as wet earth) rather than an insulator. Fortunately, in most cases, a very crude estimate of the leakage flux is adequate to provide a satisfactory value for the flux in the air gap.

5.7 Hysteresis

In the preceding sections the permeability of iron has been taken to be a constant. While this is a useful first approximation, which can be justified in a limited number of cases, it is not generally possible to regard permeability as a constant. The relationship between the magneto-motive force applied to a specimen of iron and the magnetic flux density produced is a far from simple one. The magnetization of the iron depends not just on the present value of the magneto-motive force, but also on the previous history of the specimen. In this book we are restricting our attention to macroscopic phenomena, so no attempt is made to offer an explanation of their causes in terms of the atomic theory of matter.

One way of investigating the relationship between the magneto-motive force applied to a specimen of iron and the flux density produced would be to use a magnetic circuit like the one shown in Fig. 5.5. Provided that the air gap is very small, it is possible to neglect the effects of fringing. The flux density in the air gap is then the same as that in the iron and its strength could be measured by placing a Hall probe in the gap. The total magneto-motive force applied to the circuit is NI , so the magneto-motive force applied to the iron is

$$\mathcal{M}_i = NI - \mathcal{M}_{gap} = NI - \frac{Bg}{\mu_0} \quad (5.18)$$

Now \mathcal{M}_i is the product of H_i and the length of the part of the circuit lying within the iron, so it would be possible to deduce values of H_i from measurements of the current in the coil and the flux density in the air gap. The results of such measurements are customarily displayed by plotting B_i against H_i . There are better ways of obtaining the information than the experiment described, but we are concerned here with the properties of the iron rather than the details of how they are measured.

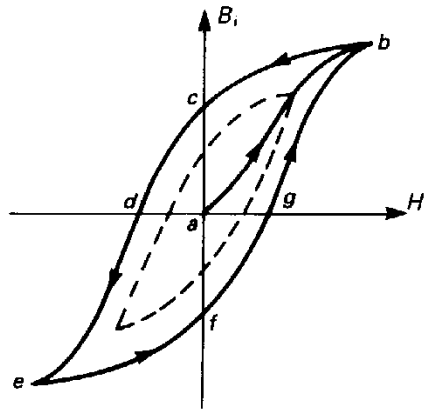

Fig. 5.9 A typical hysteresis loop showing the initial magnetisation path (*ab*), saturation (at *b*), remanence (at *c*), the coercive force (at *d*), and an inner loop (shown dotted).

SMS from your computer

...Sync'd with your Android phone & number

FREE
30 days trial!

Go to

BrowserTexting.com

and start texting from your computer!

BrowserTexting

Click on the ad to read more

Figure 5.9 shows a typical B - H curve. If the specimen of iron is initially un-magnetized, then its state can be represented by the point a at the origin of the graph. Now suppose that the current in the coil is gradually increased. It is found that the B - H curve follows the path ab , rising slowly at first, then more rapidly, and, finally, levelling off. This curve is known as the **initial magnetization curve** of the iron. When the curve levels off at high values of H , the material is said to be **saturated**.

If the current in the coil is reduced to zero, the flux density does not retrace the curve ab . Instead, it follows a curve such as bc , so that the flux density in the circuit does not fall to zero when the current is zero. The value of B at c is referred to as the **remanence** of the iron.

In order to reduce the flux in the circuit to zero it is necessary to reverse the current in the coil. The value of H needed to make B zero (the point d) is known as the **coercive force**. Increasing the current in the coil beyond the level needed to reach d eventually produces saturation of the iron at e with the direction of the flux opposite to that at b . Finally, reducing the current to zero and then increasing it with reversed polarity produces the curve $efgb$.

If the current in the coil is repeatedly taken through the same cycle, the **hysteresis loop** $bcdefgb$ is traversed repeatedly in a stable manner, provided only that the maximum value of the current in the coil is the same for both polarities. In many applications the flux in the iron is produced by a periodic (though not necessarily sinusoidal) current, and the iron then behaves in the manner described. If the maximum current is increased still further, there is no change to the loop because the magnetization of the iron cannot be increased beyond its value at saturation. If, on the other hand, a periodic current of smaller amplitude is used, it is found that the behaviour of the iron is described by a smaller loop such as the one shown dotted in Fig. 5.9.

The properties of magnetic materials can be varied by making alloys with different proportions. They are also strongly influenced by the ways in which the finished material is prepared, especially any heat treatments used. A very great variety of materials now exists. Their properties can be looked up in reference books. From a practical point of view the main division among magnetic materials is between 'hard' and 'soft' materials. The differences between these two classes are illustrated in Fig. 5.10.

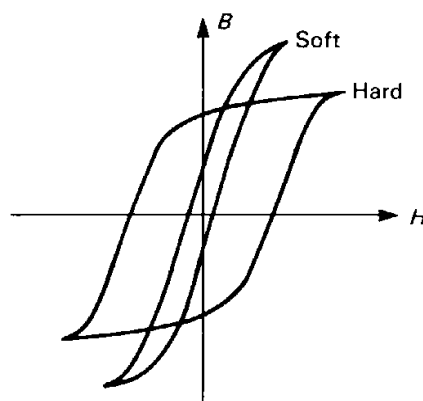

Fig. 5.10 Typical hysteresis loops for hard and soft magnetic materials.

Soft magnetic materials are characterized by having narrow hysteresis loops, low remanence and small coercive forces. They are therefore easily magnetized and demagnetized and are used as conductors of flux in magnetic circuits and magnetic screens. Because these materials have narrow hysteresis loops their behaviour can be approximated by their initial magnetization curves. Moreover, if the loop is also nearly straight for fields below saturation, like the one shown in Fig. 5.9, it is possible to make the approximation that the permeability is constant.

Hard magnetic materials have broad hysteresis loops, high remanence and high coercive forces. Such materials are difficult to demagnetize. They are used for making permanent magnets and magnetic recording materials.

A further important feature of the properties of magnetic materials is illustrated by Fig. 5.11. Suppose that the material has been magnetized to saturation (b) and then demagnetized to the point p by the application of a reverse field. If the magnetizing field is then reduced to zero, the working point of the material moves to q along a **minor loop**. Minor loops are usually narrow and it is possible to approximate the loop between p and q by the straight line pq , which is usually nearly parallel to bc . Provided that the demagnetizing field applied does not take the working point past p back onto the main loop, the material will operate in a stable manner along the minor loop pq . This fact is of considerable importance in the application of permanent magnets.

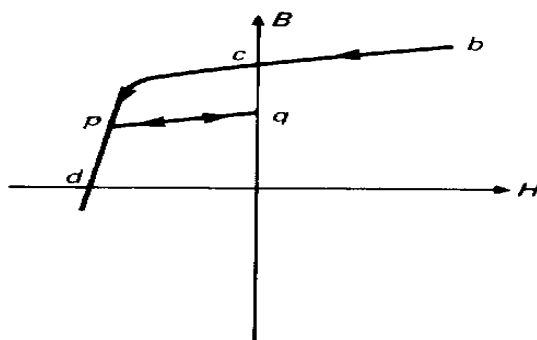

Fig. 5.11 Part of a B - H curve showing a minor loop p - q .

5.8 Solution of problems in which μ cannot be regarded as constant

Consider again the magnetic circuit shown in Fig. 5.5. Neglecting leakage and fringing fluxes we may assume that $B_i = B_a$. The application of the magnetic circuit law to the circuit gives

$$NI = 4LH_i + gH_a = 4LH_i + \frac{gB_i}{\mu_0}$$

or

$$B_i = \frac{\mu_0}{g}(NI - 4LH_i) \quad (5.19)$$

A second condition is that B_i and H_i must be related to each other by the hysteresis loop of the material:

$$B_i = f(H_i) \quad (5.20)$$

Equations (5.19) and (5.20) are a pair of simultaneous equations in B_i and H_i . However, because (5.20) is not the equation of a straight line, they are non-linear simultaneous equations.

They can be solved graphically, or by using an analytical approximation to the equation of the hysteresis loop. The graphical solution is shown in Fig. 5.12. The working point Q is at the intersection of the straight line represented by Equation (5.19) with the hysteresis loop. The intercept of this line on the horizontal axis is the total magneto-motive force in the circuit, while its slope is determined by the relative sizes of the iron path and the air gap. The method is similar to the process of finding the working point of a transistor by drawing a load line across the characteristic curves.



The Wake
the only emission we want to leave behind

Low-speed Engines Medium-speed Engines Turbochargers Propellers Propulsion Packages PrimeServ

The design of eco-friendly marine power and propulsion solutions is crucial for MAN Diesel & Turbo. Power competencies are offered with the world's largest engine programme – having outputs spanning from 450 to 87,220 kW per engine. Get up front! Find out more at www.mandieselturbo.com

Engineering the Future – since 1758.
MAN Diesel & Turbo



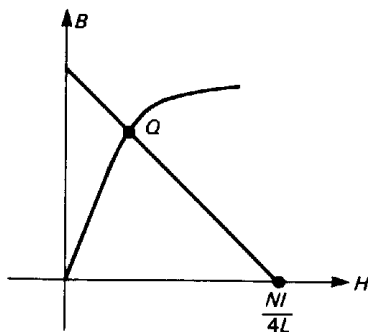

Fig. 5.12 A magnetic circuit problem can be solved by drawing a load line across the *B-H* plot for the iron. The working point of the circuit is at *Q*.

5.9 Permanent magnets

We have already noted that some magnetic materials can be magnetized so that they produce a substantial magnetic flux even when the magnetizing field is removed. These hard magnetic materials are used for making **permanent magnets**. Permanent magnets are used in loudspeakers and in a variety of microwave devices such as ferrite isolators, magnetron oscillators and travelling-wave tube amplifiers.

Figure 5.13 shows a typical *B-H* plot for a permanent magnet material. This curve, which is the part of the hysteresis loop lying in the second quadrant, is known as the **demagnetization curve** of the material.

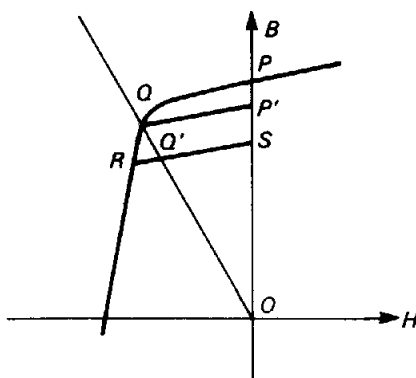

Fig. 5.13 The working point for a permanent magnet circuit lies in the second quadrant of the *B-H* plot at a point such as *Q*. A permanent magnet can be stabilized against demagnetization by external fields by operating it at a point *Q'* on a minor loop such as *R-S*.

Suppose that the circuit shown in Fig. 5.5 is made of this material and magnetized to saturation by passing a current through the coil with the air gap bridged by a piece of soft iron. When the current in the coil is reduced to zero the working point will be at *P* in Fig. 5.13. Neglecting fringing and leakage fluxes we have, when the soft iron is removed from the gap,

$$B_i = -\left(\frac{4L}{g}\right)\mu_0 H_i \tag{5.21}$$

from Equation (5.19), setting $I = 0$. This load line passes through the origin and has negative slope. It is plotted in Fig. 5.13 as the line OQ . The effect of opening the gap is therefore to demagnetize the magnet to some extent. For this reason it is common to speak of the **demagnetizing field** of the air gap.

If the piece of soft iron is reinserted in the air gap, the operating point of the magnet moves along a minor loop to the point P' . In this state the magnet is largely immune to the effects of external fields. For this reason it is usual to store permanent magnets with their air gaps bridged by a piece of soft iron known as a 'keeper'.

Suppose that someone has forgotten to put a keeper on the magnet and that it is exposed to a magnetic field which tends to demagnetize it. The working point might then move to R . When the field is removed the working point lies at Q' on the minor loop RS . This illustration shows that it is necessary to treat permanent magnets carefully if their properties are not to be affected. For example, it is unwise to try to force a pair of magnets together with their fields opposing because they are then trying to demagnetize each other.

It is not a good thing that the working point of the magnet should be sensitive to external influences in this way. For this reason permanent magnets are often stabilized by deliberately demagnetizing them beyond their working points on the main hysteresis loop. The operation of magnets which have been stabilized is stable along a minor loop (or recoil line) such as RS unless the external demagnetizing field is very strong. Smaller external fields produce a temporary shift in the working point, but it returns to Q' when the perturbing field is removed.

5.10 Using permanent magnets efficiently

In a circuit involving a permanent magnet, the cost of the magnet is usually a considerable part of the cost of the whole circuit. It is, therefore, desirable to use the magnet material as efficiently as possible. A rule of thumb for this purpose can be derived by considering the circuit shown in Fig. 5.5. Let the lengths of the magnet and the air gap be l_i and l_a and let their cross-sectional areas be A_i and A_a . The magnetic circuit law gives

$$l_i H_i + l_a H_a = 0 \quad (5.22)$$

and the conservation of flux gives

$$A_i B_i = A_a B_a \quad (5.23)$$

The volume of the magnet is

$$V_i = l_i A_i = -l_a A_a \left(\frac{H_a B_a}{H_i B_i} \right)$$

Now $l_a A_a$ is the volume of the air gap which may be taken as given, and H_a and B_a are the field strength and flux density in the air gap. So, the minimum magnet volume to provide a given flux density in a given air gap is achieved by making the product $H_i B_i$ as great as possible. This is known as **Evershed's criterion**. The quantity $H_i B_i$ is known as the **energy product** of the magnet for reasons which will become apparent in a later chapter.

Figure 5.14 shows the curves of B against H and BH against B as they are usually plotted. The optimum working point of the material is then that which gives the value of B corresponding to the maximum value of BH as shown at Q_{opt} .

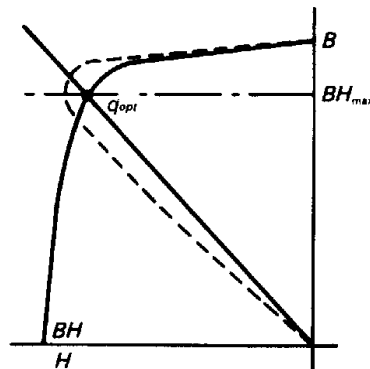

Fig. 5.14 Typical curves of H and BH versus B for a permanent magnet material showing the choice of working point at the maximum value of BH to make the most efficient use of the magnet.

TURN TO THE EXPERTS FOR SUBSCRIPTION CONSULTANCY

Subscribe is one of the leading companies in Europe when it comes to innovation and business development within subscription businesses.

We innovate new subscription business models or improve existing ones. We do business reviews of existing subscription businesses and we develop acquisition and retention strategies.

Learn more at [linkedin.com/company/subscribe](https://www.linkedin.com/company/subscribe) or contact Managing Director Morten Suhr Hansen at mha@subscribe.dk

SUBSCRIB✓**BE** - to the future

5.11 Summary

In this chapter we have considered the properties of ferromagnetic materials. We have seen that their principal characteristic is that they acquire a very strong magnetization when placed in a magnetic field. As with dielectric materials it is possible to represent the properties of the materials by introducing a new vector, in this case \mathbf{H} , which includes the effects of the polarization of the materials. Using the vector \mathbf{H} a new form of the magnetic circuit law was derived, which is valid even when magnetic materials are present.

Consideration of the boundary conditions at the surface of a ferromagnetic material showed that such materials can usually be regarded as good conductors of magnetic flux. This property allows the path of the flux to be controlled so that it is directed to the place where it is needed, as in a recording head, or directed away from sensitive areas in magnetic screening.

In a limited range of cases it is possible to regard ferromagnetic materials as being linear, but, in general, it is necessary to take account of their non-linear behaviour as described by their hysteresis loops.

6 Electromagnetic induction

Objectives

- To show that an electromotive force is induced in a conductor moving through a magnetic field, and that a current flows if the circuit is completed.
- To show that an electromotive force is induced in a loop of wire moving through a non-uniform magnetic field and that, by implication, an e.m.f. is induced in a loop of wire when the magnetic flux linked to it changes.
- To generalize the first two objectives in the form of Faraday's law of electromagnetic induction.
- To demonstrate the links between the circuit concepts of self and mutual inductance and electromagnetic field theory.
- To discuss the causes of electromagnetic interference and ways of reducing it.
- To introduce methods, including energy methods, for calculating self and mutual inductances.
- To introduce the analogy between L , C and R in two-dimensional problems.
- To discuss the concept of the storage of energy in a magnetic field, and to show the equivalence between calculations of the energy stored in an inductor from field and circuit points of view.
- To discuss the special case of energy storage in a magnetic field in iron and to introduce the idea of hysteresis loss.
- To introduce the induction of eddy currents in a conductor by a changing magnetic field.

6.1 Introduction

In this chapter we turn our attention to phenomena involving conductors and magnetic fields in relative motion, and magnetic fields which are changing with time. These effects, first investigated by Faraday in 1831, complete the link between magnetism and electricity. We have already seen how magnetic fields are produced by electric currents. We shall now show that electromotive forces and electric currents can be produced by electromagnetic induction. These ideas are fundamental to the generation of electricity by electromagnetic machines and to the use of transformers in the distribution of electric power. As far as electronic engineers are concerned their importance lies in the fact that they provide an explanation of self and mutual inductance, and the means to calculate these circuit parameters.

6.2 The current induced in a conductor moving through a steady magnetic field

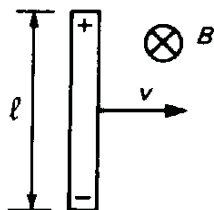

Consider a piece of straight wire moving with constant velocity v through a steady magnetic field \mathbf{B} which is at right angles to the wire and to its direction of motion, as shown in the figure on the right. The conduction electrons in the wire are carried through the field with the wire so, from Equation (4.4), each electron experiences a magnetic force qvB acting upon it. The cross product symbols have been omitted because the directions of the wire, the velocity of the wire and the field have been chosen to be mutually perpendicular. As a result of this force the electrons are displaced so that the ends of the wire acquire polarization charges, as shown in the figure.

The polarization of the wire produces an electric field within it which opposes the motion of the electrons. In equilibrium the electric force on each charge must be equal and opposite to the magnetic force, so that

$$E = vB \quad (6.1)$$

The magnitude of the potential difference between the ends of the wire is therefore

$$V = \int E \, dl = vBl \quad (6.2)$$

Now suppose that the ends of the wire are connected to parallel rails by sliding contacts and that the circuit is completed by a load resistor, as shown in Fig. 6.1. The potential difference between the ends of the rod acts as an electromotive force in the circuit and a steady current flows such that

$$IR = vBl \quad (6.3)$$

The electric power dissipated in the resistor is

$$I^2R = vBlI \quad (6.4)$$

The mechanical power input is the product of the force needed to move the wire and its velocity. Since the current in the circuit is I , the force needed to move the wire is BIl , from equation (4.18), so the mechanical power input is

$$Fv = vBIl \quad (6.5)$$

This is exactly equal to the electric power, demonstrating that this device converts mechanical energy into electrical energy.

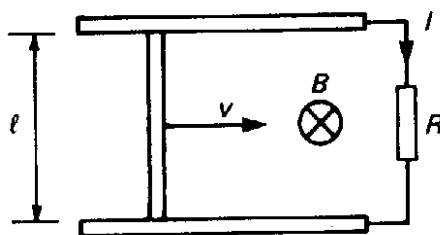

Fig. 6.1 A current is induced in a closed circuit in a magnetic field if the shape of the circuit is changed.

Examination of Fig. 6.1 shows that the force exerted on the current-carrying slider by the field is in the opposite direction to v . This internal force must be opposed by an equal and opposite external force if the wire is in steady motion. The external force is in the same direction as v , so it does work on the slider, providing a power input to the device. This simple arrangement forms the starting point for the discussion of the generation of electricity by electromagnetic machines. Important as the topic is, it is outside the scope of this book and will not be pursued any further here.

Recalling the definition of magnetic flux which was used in earlier chapters, we can see that, with the direction of velocity shown, the flux linked to the circuit of Fig. 6.1 is changing at a rate given by

$$\frac{d\Phi}{dt} = -vIB \quad (6.6)$$

but, from Equation (6.2), this is just the electromotive force developed in the circuit. The direction of the electromotive force is such that when a current flows in the circuit the magnetic forces oppose the external mechanical force which is causing the flux to change. These ideas can be combined by writing

$$\mathcal{E} = -\frac{d\Phi}{dt} \quad (6.7)$$

6.3 The current induced in a loop of wire moving through a non-uniform magnetic field

In the experiment described in the previous section it was shown that a current could be induced in a circuit by altering the shape of the circuit and so changing the flux linked to the circuit. It is interesting to see whether a current could also be induced by keeping the shape of the circuit fixed and varying the strength of the magnetic field. This could be achieved by taking a square loop of wire, as shown in Fig. 6.2(a), and moving it with a steady velocity v through a magnetic field perpendicular to the plane of the loop whose variation with position in the direction of motion is given by the graph of Fig. 6.2(b).

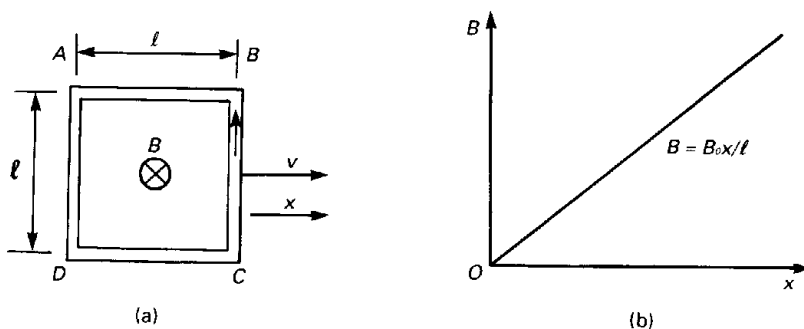

Fig. 6.2 A current is induced in a closed loop of wire when it is moved through a non-uniform magnetic field at right angles to the plane of the loop.

wethrive.net

How to retain your top staff
FIND OUT NOW FOR FREE

DO YOU WANT TO KNOW:

- What your staff really want?
- The top issues troubling them?
- How to make staff assessments work for you & them, painlessly?

Get your free trial
 Because happy staff get more done



At the instant when the wire AD is at x relative to the origin, the e.m.f. generated in it is

$$\mathbf{E}_{AD} = \nu l B_0 \left(\frac{x}{l} \right) \quad (6.8)$$

where the order of the subscripts shows that the polarity of the e.m.f. is such as to drive a current from A to D through the rest of the circuit. In the same way the e.m.f. generated in BC is

$$\mathbf{E}_{BC} = \nu l B_0 \left(\frac{x+l}{l} \right) \quad (6.9)$$

The remaining sides of the loop are moving parallel to their own directions so no potential differences are generated between their ends. The net e.m.f. in the circuit is therefore

$$\mathbf{E} = \nu l B_0 \left(\frac{x+l}{l} - \frac{x}{l} \right) = \nu l B_0 \quad (6.10)$$

directed so as to tend to drive a current in a counter-clockwise direction. Now the flux linked to the circuit is

$$\Phi = l^2 B_0 \left(\frac{x+l/2}{l} \right) \quad (6.11)$$

so that

$$\frac{d\Phi}{dt} = l B_0 \frac{dx}{dt} = \nu l B_0 \quad (6.12)$$

So, in this case also, the e.m.f. is equal to the rate of change of flux linkage. The direction of the flux produced by the induced current is opposed to the original field, so that it tends to prevent the flux linked to the loop from increasing as the loop is moved. Since it is the relative motion of the loop and the field which produces the e.m.f. it is reasonable to suppose that the same result would have been produced if the loop had been held fixed and the source of the field moved with velocity ν in the negative x -direction.

6.4 Faraday's law of electromagnetic induction

In the previous sections it has been shown that, at least in the two cases considered, an electromotive force is induced in a circuit when the magnetic flux linked to the circuit is changed. This phenomenon was observed experimentally by Faraday, who generalized his findings in the law which bears his name.

Faraday's law of electromagnetic induction states that, *if the flux linked to a circuit is changed in any way, then an electromotive force is induced in the circuit whose magnitude is proportional to the rate of change of the flux linkage to the circuit.*

The term **flux linkage** is used here to include circuits such as coils in which the wire encircles the path of the circuit more than once. In these cases the flux linked to the circuit is the sum of the flux linkage to the individual turns. It is often possible to make the approximation that the flux linkage to each turn of a coil is the same, so that the total flux linkage is the product of the flux linked to one turn and the number of turns. Denoting flux linkage by Λ , this relationship is expressed by the equation

$$\Lambda = N\Phi \quad (6.13)$$

We have also seen that the direction of the e.m.f. induced in a circuit by a changing magnetic flux linkage is always such that it tries to oppose the change of flux which causes it. This statement is known as **Lenz's law**.

Faraday's law can be expressed in mathematical terms by writing

$$\mathbf{E} = -\frac{d\Lambda}{dt} \quad (6.14)$$

For a simple circuit such as that shown in Fig. 6.3, the flux linkage is given by

$$\Lambda = \int_S \mathbf{B} \cdot d\mathbf{A} \quad (6.15)$$

where the integration is carried out over an open surface spanning the circuit and the elementary vectors $d\mathbf{A}$ are taken to point upwards as shown.

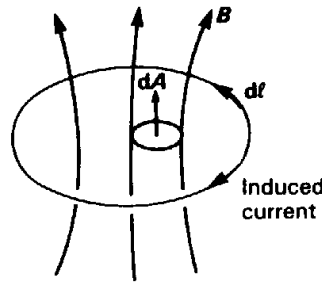

Fig. 6.3 The direction of the current induced in a loop of wire by a magnetic flux which is increasing with time.

The e.m.f. in the circuit can be calculated in a similar manner by making use of Equation (3.17). The direction of the line integral around the circuit is chosen to be in a right-hand corkscrew sense with respect to the direction of the vector $d\mathbf{A}$. This direction is shown in Fig. 6.3 by the direction of the elementary vector $d\mathbf{l}$. Thus

$$\mathbf{E} = \oint \mathbf{E} \cdot d\mathbf{l} \quad (6.16)$$

Now, if \mathbf{B} is in the direction shown and it is increasing in magnitude with time, Lenz's law requires the direction of the induced current to be opposite to the direction of the line integral as shown in Fig. 6.3.

Substituting for E and Λ in Equation (6.14) produces a general mathematical form of Faraday's law:

$$\oint \mathbf{E} \cdot d\mathbf{l} = -\frac{d}{dt} \iint \mathbf{B} \cdot d\mathbf{A} \quad (6.17)$$

Although this expression may seem abstract and complicated it should be remembered that it is no more than a restatement of Faraday's law and Lenz's law in the symbolic language of mathematics.

When a circuit has more than one turn, the integral on the right-hand side of Equation (6.17) is taken over all the turns. In the problems which are of interest in electronics the circuit is normally fixed and the magnetic field changing with time. Under these circumstances the differentiation can be brought inside the integral to give

$$\oint \mathbf{E} \cdot d\mathbf{l} = -\iint \frac{\partial \mathbf{B}}{\partial t} \cdot d\mathbf{A} \quad (6.18)$$

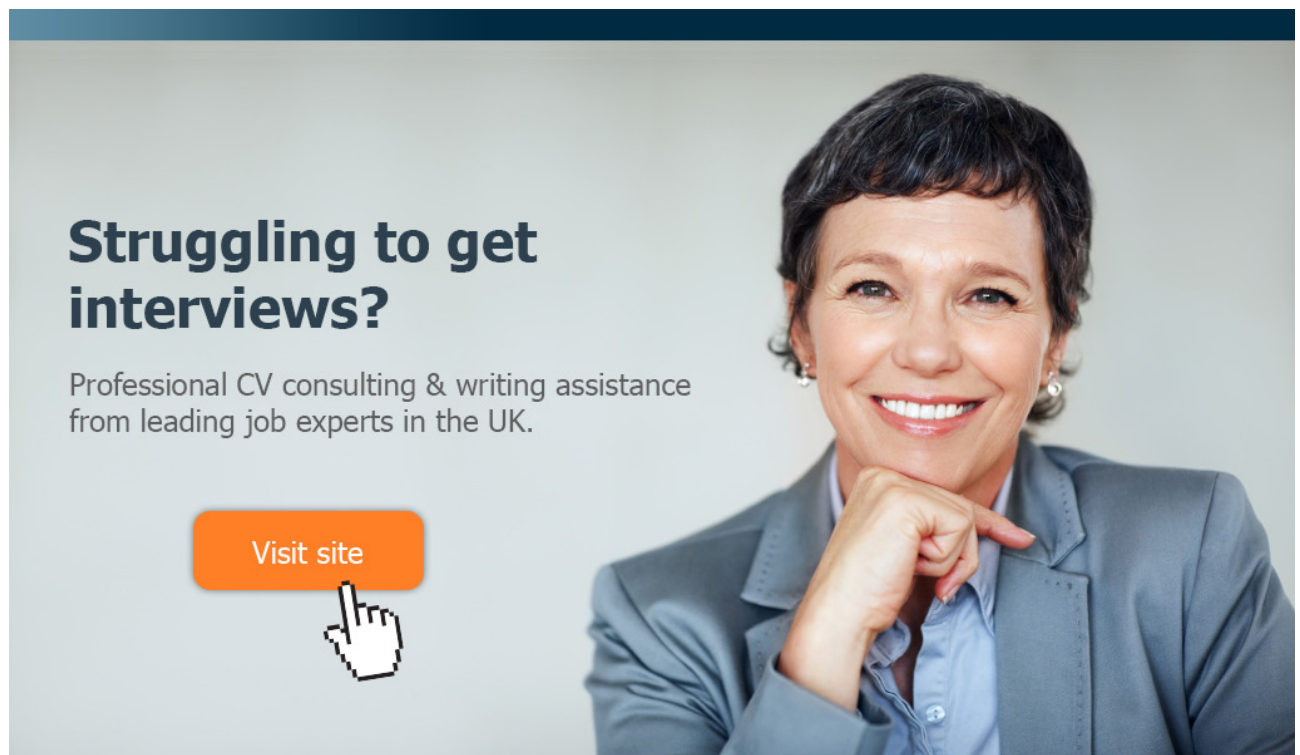

Struggling to get interviews?

Professional CV consulting & writing assistance from leading job experts in the UK.

[Visit site](#)



Take a short-cut to your next job!
Improve your interview success rate by 70%.



TheCVagency
Visit theagency.co.uk for more info.



Click on the ad to read more

6.5 Inductance

We are now in a position to consider the third of the trio of passive circuit parameters, resistance, capacitance and inductance. Figure 6.4 shows two loops of wire arranged so that when a current is passed through loop 1 some of the flux produced passes through loop 2 and vice versa.

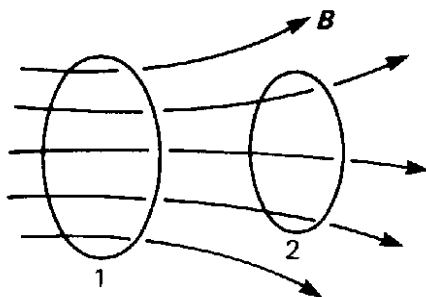

Fig. 6.4 Two loops of wire are inductively linked when some or all of the magnetic flux produced by one of them passes through the other.

Suppose that the flux linked to loop 2 is Λ_{21} when the current in loop 1 is I_1 . If the loops are in a region of constant permeability, then Λ_{21} is proportional to I_1 . The constant of proportionality is

$$L_{21} = \frac{\Lambda_{21}}{I_1} \tag{6.19}$$

where L_{21} is the **mutual inductance** coupling the loops. From Equation (6.19) it is evident that inductance has the dimensions weber per ampere, and this unit is called the **Henry** (H). The ratio of the flux linked to loop 1 to the current in the same loop is the **self-inductance** of that loop, given by

$$L_{11} = \frac{\Lambda_{11}}{I_1} \tag{6.20}$$

Two similar equations can be derived by assuming that the source current is in loop 2.

These equations can then be brought together by using the principle of superposition to give

$$\begin{aligned} \Lambda_1 &= \Lambda_{11} + \Lambda_{12} = L_{11}I_1 + L_{12}I_2 \\ \Lambda_2 &= \Lambda_{21} + \Lambda_{22} = L_{21}I_1 + L_{22}I_2 \end{aligned} \tag{6.21}$$

As this is a passive linear system the matrix of the coefficients of inductance must be symmetrical; that is

$$L_{21} = L_{12} = M \tag{6.22}$$

where M is the mutual inductance of the loops. Using this notation the double subscripts can be dropped and the self inductances represented by the symbols L_1 and L_2 . When Faraday's law is applied to equations (6.21), we obtain

$$\begin{aligned} \mathbf{E}_1 &= -L_1 \frac{dI_1}{dt} - M \frac{dI_2}{dt} \\ \mathbf{E}_2 &= -M \frac{dI_1}{dt} - L_2 \frac{dI_2}{dt} \end{aligned} \quad (6.23)$$

where the positive directions of the currents and the e.m.f.s are the same. These are the familiar circuit equations for inductively coupled circuits. It is important to remember that these equations hold only when the system is linear, that is, when the fluxes are directly proportional to the currents producing them. Since the behaviour of iron can be highly non-linear, as we saw in Chapter 5, it cannot be taken for granted that iron-cored inductors behave as linear circuit elements.

The self and mutual inductances in a circuit are related to each other, as will now be demonstrated. Consider again the pair of loops shown in Fig. 6.4, but suppose that loop 1 is a coil of N_1 turns and coil 2 has N_2 turns. When a current I_1 flows in 1 a flux Φ_1 is generated. For the sake of simplicity it will be assumed that the whole of this flux is linked to every turn in coil 1, so that

$$\Lambda_1 = N_1 \Phi_1 \quad (6.24)$$

In general, not all of the flux will pass through coil 2 so that the flux linked to that coil can be written

$$\Lambda_2 = k_2 N_2 \Phi_1 \quad (6.25)$$

where k_2 is the proportion of the flux generated by coil 1 which is linked to coil 2. It follows that $k_2 \leq 1$.

Assuming linearity, we can write

$$\frac{M}{L_1} = \frac{\Lambda_2}{\Lambda_1} = \frac{k_2 N_2}{N_1} \quad (6.26)$$

If a current is passed through coil 2 we obtain, by a similar argument

$$\frac{M}{L_2} = \frac{\Lambda_1}{\Lambda_2} = \frac{k_1 N_1}{N_2} \quad (6.27)$$

where k_1 is the fraction of the flux produced by coil 2 which passes through coil 1. Multiplying Equations (6.26) and (6.27) together gives

$$M^2 = k_1 k_2 L_1 L_2 = k^2 L_1 L_2 \quad (6.28)$$

where the coupling coefficient $k = \sqrt{k_1 k_2} \leq 1$.

6.6 Electromagnetic interference

In Chapter 2 we saw that there can be unwanted capacitive coupling between two circuits. Similar problems can arise through inductive coupling. Figure 6.5 shows a simple example of the coupling of two circuits through their mutual inductance M . If an alternating current flows in circuit 1, then it produces a magnetic flux, some of which may be linked to circuit 2.

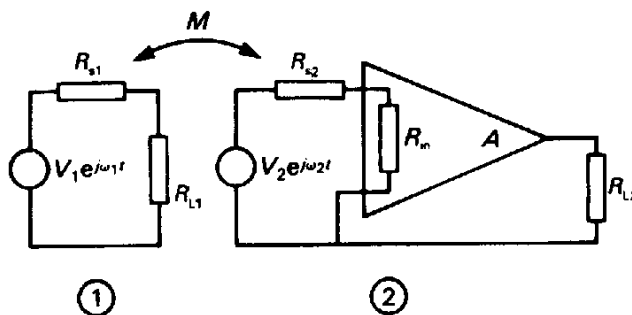

Fig. 6.5 When two circuits are coupled by stray mutual inductance the signal in one circuit can interfere with that in the other. For example, if circuit 1 is the a.c. mains a spurious 50 Hz signal could be added to the signal V_2 in circuit 2.

To simplify matters we will assume that I_1 is much greater than I_2 so that, approximately,

$$I_1 = \frac{1}{R_{S1} + R_{L1}} V_1 \exp(j\omega_1 t)$$

Click on the ad to read more

and the e.m.f. induced in circuit 2 is

$$V_i = -M \frac{dI_1}{dt} = -\frac{j\omega_1 M}{R_{S1} + R_{L1}} V_1 \exp(j\omega_1 t) \quad (6.29)$$

This voltage is added to the signal voltage in circuit 2. The interference is worst when V_1 is large and the loop impedance of circuit 1 is small. The commonest example of this is when circuit 1 represents the a.c. mains and the interference appears as 50 Hz ‘mains hum’. In this case it is not possible to reduce the interference by altering V_1 or $(R_{S1} + R_{L1})$ and effort has to be concentrated on reducing M . To do this we have to reduce the proportion of the flux produced by circuit 1 which is linked into circuit 2.

Three strategies are possible:

1. *Reduce the area of circuit 2*

If the signal source V_2 is a transducer some distance from the amplifier, then this can be achieved by using a pair of wires twisted together (a ‘twisted pair’) to connect them together.

2. *Rotate circuit 2 so that its plane is parallel to the flux produced by circuit 1*

Rotating one circuit relative to the other can reduce the flux linkage to zero. If the two circuits are to be enclosed in the same case in fixed positions this can be a useful approach.

3. *Put a screen of high permeability magnetic material in a position which screens circuit 2 from the flux of circuit 1.*

The special alloy known as mumetal ($\mu_r \approx 10^5$) is used for this purpose. This method works only at low frequencies.

A particularly troublesome type of electromagnetic interference is caused by **earth loops**. Figure 6.6 shows a typical situation in which this problem occurs. Two electronic instruments, A and B, are connected to the main supply by three-core cables whose earth conductors are connected to the instrument frames. The instruments are also connected to each other by a coaxial cable whose sheath is connected to the frames of the instruments to screen the signal wire from capacitively coupled interference. This arrangement produces a closed earth loop as shown by the cross-hatching in Fig. 6.6.

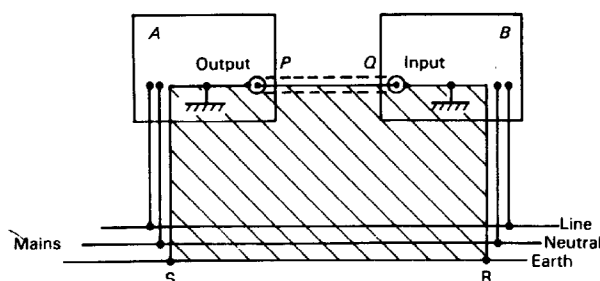

Fig. 6.6 An earth loop, shown shaded, can be formed by the earth conductors of the electricity supply to two electronic instruments and the sheath of the coaxial cable connecting them together.

The earth loop has low resistance and large currents can be induced in it by the flux of the mains or of some other source of interference. The induced current (I_i) flows through the resistance of the sheath of the coaxial cable (R_c) as shown in Fig. 6.7. This produces a spurious potential difference between P and Q which is added to the signal voltage V_A .

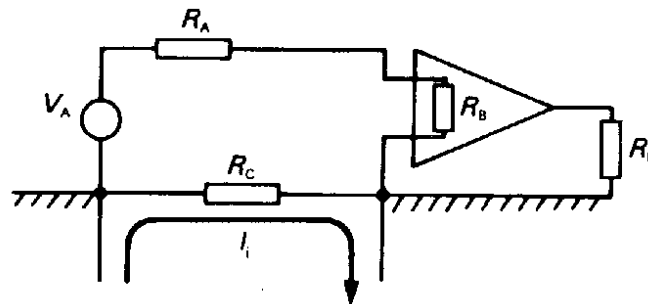

Fig. 6.7 The potential difference across the resistance R_c of the sheath of the coaxial cable in Fig. 6.6 produced by the circulating earth loop current I_i is in series with the signal source V_A .

Two solutions to this problem are possible:

1. *Break the earth loop so that no current can flow in it.*

This is not as simple as it seems. Disconnecting the earth lead from the plug at R or S is potentially very dangerous because lethal voltages could appear on the instrument frames under fault conditions. This solution is only possible if a permanent earth connection between A and B can be ensured, for example by bolting them to the same rack. Ideally there should only be one path to earth from any point on the equipment. The alternative of disconnecting the cable sheath at P means that the signal earth follows the path $PSRQ$. The mutual inductance between this circuit and the mains is high.

2. *Increase the resistance of the earth loop.*

This can be achieved by putting resistors between the signal earth and the frame of each instrument as shown in Fig. 6.8. If the added resistors (R_D) are much larger than R_C then the circulating current in the earth loop is reduced because the e.m.f. is fixed. The unwanted voltage appearing across R_C is reduced by a factor which is approximately $R_C/2R_D$. It is important that R_D is small enough so that no part of the system which can be touched reaches a lethal voltage when the maximum fault current is flowing. If $R_C = 0.1 \Omega$ and $R_D = 50 \Omega$, then the interference voltage is reduced by a factor of 1000. If, also, the mains fuse of each instrument is rated at 250 mA, then the voltage at P or Q cannot exceed 12.5 V with respect to earth.

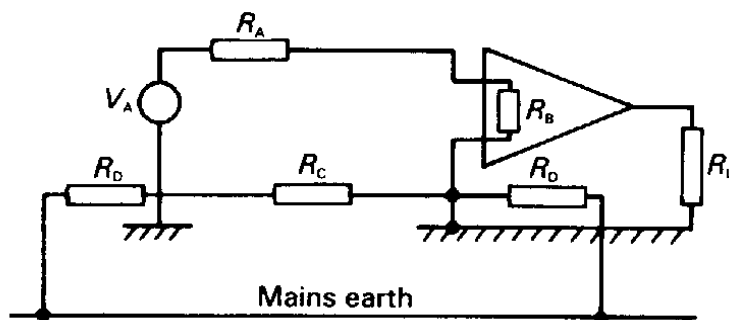

Fig. 6.8 The resistance of the earth loop can be increased by connecting resistors R_D between the signal earth and the supply earth of electronic instruments.

6.7 Calculation of inductance

Before proceeding to a discussion of the ways of calculating inductance it is useful to review the situations in which such a calculation might be necessary. They are:

- To find the self and mutual inductances of circuit components such as inductors and transformers.
- To find the inductance per unit length of two-wire transmission lines.
- To estimate the stray mutual inductance between parts of a circuit such as parallel tracks on a printed circuit board.

This e-book
is made with
SetaPDF



SETASIGN



PDF components for PHP developers

www.setasign.com



Inductance is calculated either by assuming a distribution of currents and computing the flux linkage, or by assuming a flux distribution and then finding the ampere turns needed to produce it. The first approach is best for many purposes, but we shall see later in the chapter that the two methods lead to upper and lower bounds for the inductance when energy methods are used. The calculation of inductance in simple cases may be illustrated by two examples.

Figure 6.9 shows a simple transformer in which the primary and secondary windings having N_1 turns and N_2 turns respectively are wound upon an iron core whose permeability is μ . The mean path length of the magnetic circuit is L and its cross-sectional area is A .

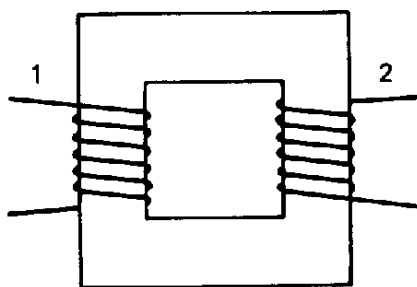

Fig. 6.9 The arrangement of a simple transformer.

Let a current I_1 flow in the primary winding, then, by the magnetic circuit law the magnetic field in the core is

$$H = \frac{N_1 I_1}{L} \tag{6.30}$$

and the flux in the core is

$$\Phi = BA = \mu HA = \frac{\mu N_1 A}{L} I_1 \tag{6.31}$$

The fluxes linked to the primary and secondary windings are

$$\Lambda_1 = N_1 \Phi = \frac{\mu N_1^2 A}{L} I_1 \quad \text{and} \quad \Lambda_2 = N_2 \Phi = \frac{\mu N_1 N_2 A}{L} I_1 \tag{6.32}$$

so that the self and mutual inductances are

$$L_1 = \frac{\Lambda_1}{I_1} = \frac{\mu N_1^2 A}{L} \quad \text{and} \quad M = \frac{\Lambda_2}{I_1} = \frac{\mu N_1 N_2 A}{L} \tag{6.33}$$

In the same way by assuming that a current I_2 flows in the secondary winding we obtain

$$L_2 = \frac{\Lambda_2}{I_2} = \frac{\mu N_2^2 A}{L} \quad \text{and} \quad M = \frac{\Lambda_1}{I_2} = \frac{\mu N_1 N_2 A}{L} \tag{6.34}$$

We have shown, incidentally, that Equation (6.22) is valid for this case and that $M^2 = L_1 L_2$ as would be expected from Equation (6.28) for the perfect coupling between the windings which has been assumed here.

In real transformers there is always some leakage of flux, so that the inductances calculated in this way are only approximate. To achieve greater accuracy it would be necessary to compute the detailed distribution of flux in and around the core. The effects of leakage can be minimized by using multilayer windings.

At frequencies above 50 Hz the capacitance between the windings can be important because it limits the band of frequencies over which the transformer will work. The complete transformer can be represented by an equivalent circuit and methods exist for calculating the parameters of the circuit for any particular design of transformer. The core can be regarded as linear to a first approximation if it is made of a soft magnetic material and operated well below saturation. Inductors ('chokes') only have a single winding. They are sometimes made with an air gap in the magnetic circuit, so that the reluctance of the circuit is dominated by the reluctance of the gap and is, therefore, linear.

Figure 6.10 shows unit length of a coaxial cable whose inner and outer conductors have radii a and b respectively. We wish to find an expression for the series inductance per unit length of the line.

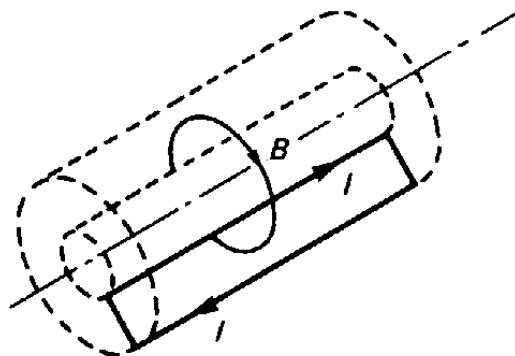

Fig. 6.10 A coaxial cable

If the ends of the cable are short-circuited then the two conductors form a closed circuit as shown. If the magnetic circuit law is applied to a circular path which is concentric with the cable then net current is only enclosed when the path lies in the space between the conductors. Thus there is a magnetic field only in the space between the conductors and, from considerations of symmetry, it must be directed in the tangential direction as shown.

Let the current in the conductors be I then using the magnetic circuit law we find that the magnetic field strength on a path between the conductors at radius r is

$$H = \frac{I}{2\pi r} \quad (6.35)$$

The conductors form a closed circuit having only a single turn, so the flux linked to it is found by calculating the flux crossing a unit length of a radial plane, as shown in Fig. 6.10. Thus, assuming that the material in the space between the conductors is non-magnetic

$$\Lambda = \int_a^b \frac{\mu_0 I}{2\pi r} dr = \frac{\mu_0 I}{2\pi} \ln\left(\frac{b}{a}\right) \quad (6.36)$$

The inductance per unit length is the flux linkage per unit current

$$L = \frac{\Lambda}{I} = \frac{\mu_0}{2\pi} \ln\left(\frac{b}{a}\right) \quad (6.37)$$

The significance of this result will become apparent in Chapter 7 when the use of coaxial cables as transmission lines is discussed. The estimation of the inductance per unit length of transmission lines of other shapes can be achieved by energy methods. This topic is treated later in this chapter.

6.8 Energy storage in the magnetic field

In Chapter 2 we saw that the work done in setting up an electric field could be thought of as being stored either in a lumped manner in the capacitance of the system ($\frac{1}{2}CV^2$) or distributed throughout space with an energy density $\frac{1}{2}\mathbf{D}\cdot\mathbf{E}$. In just the same way the work done in setting up a magnetic field can be regarded as being stored either in the circuit inductance or distributed throughout the magnetic field.

**YOU THINK.
YOU CAN WORK
AT RMB**

**RAND
MERCHANT
BANK**
A Division of FirstRand Bank Limited
Traditional values. Innovative ideas.

Rand Merchant Bank uses good business to create a better world, which is one of the reasons that the country's top talent chooses to work at RMB. For more information visit us at www.rmb.co.za

Thinking that can change your world

Rand Merchant Bank is an Authorised Financial Services Provider



Click on the ad to read more

It is well known from elementary circuit theory that the energy stored in an inductor is given by

$$W = \int_0^I Li \, di = \frac{1}{2} LI^2 \quad (6.38)$$

An alternative expression for W is obtained by substituting Λ/I for L

$$W = \frac{1}{2} \Lambda I \quad (6.39)$$

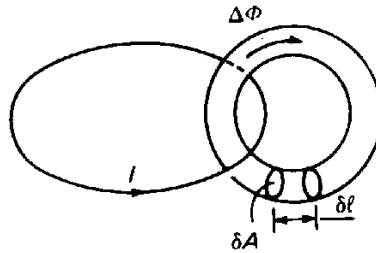

To derive an expression for the energy density in a magnetic field we consider a current loop and a typical flux tube linked to it, as shown in the figure on the right. The stored energy associated with the tube, obtained from Equation (6.39), is

$$\Delta W = \frac{1}{2} \Delta\Phi I \quad (6.40)$$

Now, if the cross-sectional area of the flux tube at a particular point is δA and the flux density at the same point is \mathbf{B} , then

$$\Delta\Phi = \mathbf{B} \cdot \delta\mathbf{A} \quad (6.41)$$

Applying the magnetic circuit law to the flux tube gives

$$I = \oint \mathbf{H} \cdot d\mathbf{l} \approx \sum H \delta l \quad (6.42)$$

if the flux tube is considered to be made up of volume elements of length δl as shown in the figure above. Substituting in Equation (6.40) for $\Delta\Phi$ and I produces

$$\Delta W = \frac{1}{2} (B \delta A) \sum (H \delta l) = \frac{1}{2} \sum (BH \delta A \delta l) \quad (6.43)$$

where the vector dot products have been dropped because the vectors concerned are all parallel to each other from the definition of the flux tube. $(B \delta A)$ is a constant of the flux tube, so it is permissible to bring it inside the summation. Finally, noting that the product $(\delta A \delta l)$ is just the volume, δv , of the element defined by them, the energy stored in the flux tube becomes

$$\Delta W = \sum \frac{1}{2} BH \, dv \quad (6.44)$$

so that the energy density in the magnetic field is evidently $\frac{1}{2}BH$. As in the case of the electric field considered in Chapter 2, a more rigorous derivation shows that the energy density in the field is given in general by

$$w = \frac{1}{2} \mathbf{B} \cdot \mathbf{H} \quad (6.45)$$

so that the total energy stored may be written

$$W = \frac{1}{2} \iiint \mathbf{B} \cdot \mathbf{H} \, dv \quad (6.46)$$

6.9 Calculation of inductance by energy methods

We have seen that energy methods provide a useful way of obtaining quite good approximations to capacitance and resistance in cases which cannot be solved by analytically. These methods can also be used to estimate inductances. The argument runs exactly parallel to the cases of capacitance and resistance so it will not be given in detail. Starting from Equation (6.38) we discover that

$$L \leq \frac{2W'}{I^2} \quad (6.47)$$

where W' is the estimate of the stored energy produced by assuming that the current distribution is given. The corresponding lower bound can be obtained by making use of the definition of self-inductance to give another expression for the stored energy

$$W = \frac{\Lambda^2}{2L} \quad (6.48)$$

If an estimate W'' of the stored energy is obtained by assuming that the flux distribution is given, then

$$L \geq \frac{\Lambda^2}{2W''} \quad (6.49)$$

6.10 The LCRZ analogy

From Equation (2.10) it is easy to show that the shunt capacitance per unit length of a coaxial cable is

$$C = \frac{2\pi\epsilon}{\ln(b/a)} \quad (6.50)$$

A comparison between Equations (6.37) and (6.50) shows a marked resemblance. This suggests that, if we can calculate the capacitance for a particular two-dimensional arrangement of electrodes, we should be able to deduce an inductance for the same geometry from it. The justification for this is that the field patterns in each case must satisfy Laplace's equation (1.27). Since this also applies to current flowing in a conductor, we can add resistance to the discussion. We will assume that the medium between the electrodes has the same properties everywhere.

It is easy to show that the resistance per unit length for radial current flow between concentric electrodes (Fig. 6.11(a)) separated by a uniform conducting material of resistivity ρ is given by

$$R = \frac{\rho}{2\pi} \ln(b/a) \quad (6.51)$$



Discover the truth at www.deloitte.ca/careers

Deloitte.

© Deloitte & Touche LLP and affiliated entities.



Click on the ad to read more

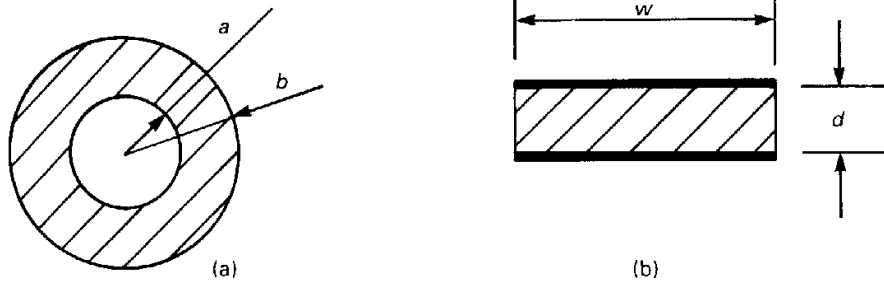

Fig. 6.11 (a) Coaxial and (b) parallel strip geometries

Similarly, for the parallel strip geometry shown in Fig. 6.11(b) we obtain the following parameters per unit length if fringing fields are neglected:

$$C = \varepsilon w/d \quad (6.52)$$

$$L = \mu d/w \quad (6.53)$$

$$R = \rho d/w \quad (6.54)$$

We deduce that for all such two-dimensional arrangements of electrodes the parameters per unit length are given by

$$C = \varepsilon \Gamma \quad (6.55)$$

$$L = \mu/\Gamma \quad (6.56)$$

$$R = \rho/\Gamma \quad (6.57)$$

where the parameter Γ is determined solely by the geometry of the electrodes. For coaxial geometry

$$\Gamma = \frac{2\pi}{\ln(b/a)} \quad (6.58)$$

and for parallel strips

$$\Gamma = w/d \quad (6.59)$$

By multiplying Equations (6.55) and (6.56) together we obtain

$$LC = \varepsilon\mu \quad (6.60)$$

which is a constant whose value depends only on the properties of the material surrounding the electrodes.

Dividing Equation (6.56) by Equation (6.55) and taking the square root we get

$$\sqrt{\frac{L}{C}} = \sqrt{\frac{\mu}{\epsilon}} \left(\frac{1}{\Gamma} \right) = \frac{Z}{\Gamma} \tag{6.61}$$

where Z has the dimensions of resistance and depends only upon the properties of the material.

Equations (6.55) to (6.57) can be used to find any two of the three parameters C , L and R for a particular geometry once one of them is known. Note carefully that the magnetic flux lines in each case are at right angles to the electric field lines. The significance of this will become apparent in Chapter 7.

These ideas can be extended further by invoking the principle of duality discussed in section 3.6 in which the roles of the flux lines and equipotentials are exchanged. It is easy to see from Fig. 6.11(b) that the parameters of the dual system are given by

$$C' = \epsilon/\Gamma \tag{6.62}$$

$$L' = \mu\Gamma \tag{6.63}$$

$$R' = \rho\Gamma \tag{6.64}$$

6.11 Energy storage in iron

So far our discussion of energy in magnetic fields has been restricted to those cases where the permeability is constant. To investigate storage of energy when the permeability is not constant, we consider an iron ring of mean circumference l and cross-sectional area A which has N turns of wire wound upon it, as shown in Fig. 6.12.

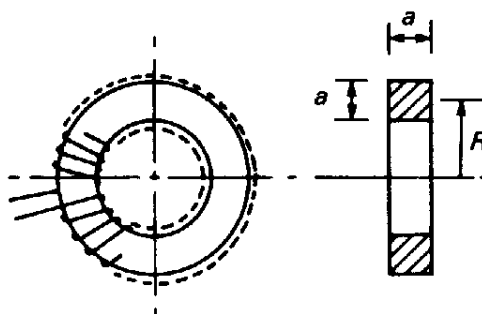

Fig. 6.12 The arrangement of a toroidal inductor

In time dt let the current in the winding increase from I to $(I + dI)$ and the flux in the iron increase from Φ to $(\Phi + d\Phi)$. The induced e.m.f. in the winding is $N d\Phi/dt$ so the work done in the time interval is

$$dW = NI \frac{d\Phi}{dt} dt = NI d\Phi \tag{6.65}$$

But

$$\Phi = BA \quad \text{and} \quad Hl = NI$$

so

$$dW = Al H dB \tag{6.66}$$

The change in the stored energy when the system is taken from flux density B_1 to B_2 is given by

$$W = Al \int_{B_1}^{B_2} H dB \tag{6.67}$$

But Al is just the volume of the iron, so the change of energy density is

$$w = \int_{B_1}^{B_2} H dB \tag{6.68}$$

Once again more rigorous argument shows that Equation (6.68) is correct for all cases if the scalar product $H dB$ is replaced by a vector dot product $\mathbf{H} \cdot d\mathbf{B}$. The work done in magnetizing an initially unmagnetized specimen of iron is illustrated by Fig. 6.13. The integral in Equation (6.68) is represented by the shaded area between the initial magnetization curve and the vertical axis.

**I WANT TO CHANGE DIRECTION,
AND THE WORLD.**

GOT-THE-ENERGY-TO-LEAD.COM

We believe that energy suppliers should be renewable, too. We are therefore looking for enthusiastic new colleagues with plenty of ideas who want to join RWE in changing the world. Visit us online to find out what we are offering and how we are working together to ensure the energy of the future.

RWE
The energy to lead

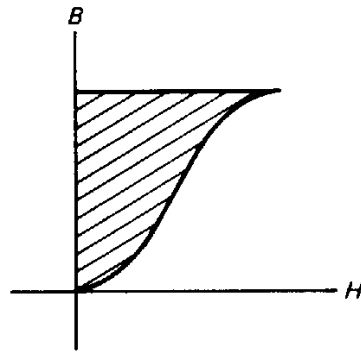

Fig. 6.13 The work done in magnetizing a piece of iron is represented by the area between the initial magnetization curve and the vertical axis.

6.12 Hysteresis loss

A case of particular interest is the work done in taking a piece of iron once around its hysteresis loop. In any iron-cored inductor or transformer the core is taken through this cycle for every cycle of the a.c. current in the windings. Figure 6.14 shows a typical hysteresis loop. The change in stored energy per unit volume in going from 1 to 2 is represented by the shaded area in Fig. 6.15(a). Let us denote this energy by w_{12} .

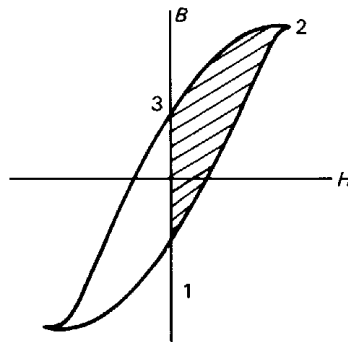

Fig. 6.14 The work done in taking a piece of iron around its hysteresis loop is proportional to the area of the loop.

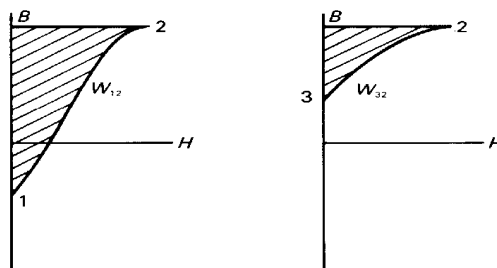

Fig. 6.15 (a) The increase in the stored energy of a piece of iron when it is taken around its hysteresis loop from 1 to 2; (b) the energy recovered when it is taken from 2 to 3.

The shaded area in Fig. 6.15(b) represents the change in stored energy per unit volume when the iron is taken from 3 to 2, a change which is mathematically possible but physically impossible. This energy is w_{32} . The real physical change is obtained by exchanging the limits of integration in Equation (6.68) so that $w_{23} = -w_{32}$. The change in energy density resulting from going from 1 to 3 via 2 is

$$w_{13} = w_{12} - w_{32}$$

which is represented by the difference between the areas shown in Figs 6.15(a) and 6.15(b), and by the shaded area in Fig. 6.14. Since the hysteresis loop is symmetrical the work done in encircling the loop once is equal to the area of the loop multiplied by the volume of the iron. It is evident that this work is not zero since all real ferromagnetic materials have hysteresis loops with non-zero areas.

This phenomenon means that electrical energy is changed into heat in the iron core at a rate proportional to the frequency of the signal applied to the device. The conversion of energy in this way is known as **hysteresis loss**. The loss is minimized by using soft magnetic materials for transformer cores, as an examination of Fig. 5.10 will show.

6.13 Eddy currents

When any conducting circuit is placed in a changing magnetic field currents are induced in the circuit, as we saw earlier. This remains true when the circuit is a solid piece of metal. In that case currents, known as **eddy currents**, circulate within the metal, causing power loss by ohmic heating. They are put to use in the industrial eddy-current heating (ECH) process, which is used for brazing metal components together. In other cases, particularly in transformer cores, they give rise to unwanted losses.

The full theory of the generation of eddy currents is beyond the scope of this book, but it is possible to give an approximate treatment of the special case in which the conductor is in the form of a thin strip with the magnetic field parallel to its length.

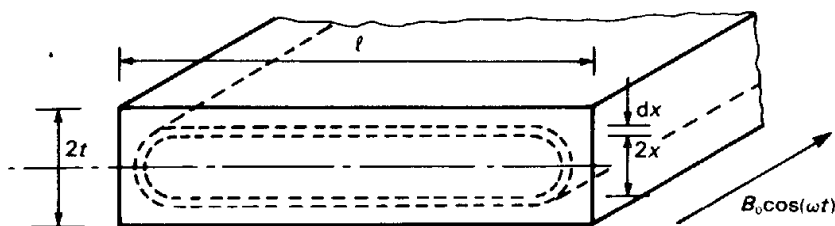

Fig. 6.16 The element of volume used in estimating the eddy-current loss in a thin conducting strip.

Figure 6.16 shows a section of a strip of conducting material whose width (l) is much greater than its thickness ($2t$). The strip is placed in a uniform magnetic field directed along the strip with flux density $B_0 \cos(\omega t)$. The eddy currents in the strip flow in closed loops like the one shown. From Faraday's law we know that the e.m.f. induced in the loop is given approximately by

$$\mathbf{E} = -2lx \frac{dB}{dt} = 2lx\omega B_0 \sin(\omega t) \quad (6.69)$$

since the area of the loop is approximately $2lx$.

The resistance of the loop is approximately

$$R = \frac{2\rho l}{dx} \quad (6.70)$$

per unit length of the strip, where ρ is the resistivity of the material.

The mean power loss in the loop is

$$dW = \frac{|\mathbf{E}|^2}{2R} = \left(\frac{l\omega^2 B_0^2}{\rho} \right) x^2 dx$$

bookboon.com

Corporate eLibrary

See our Business Solutions for employee learning

[Click here](#)

Management Time Management

Problem solving Self-Confidence Effectiveness

Project Management Goal setting Motivation Coaching



Click on the ad to read more

so that the mean power loss per unit length of the strip is

$$W = \left(\frac{l \omega^2 B_0^2}{\rho} \right) \int_0^t x^2 dx = \frac{lt^3 \omega^2 B_0^2}{3\rho} \quad (6.71)$$

We can also express this as mean power loss per unit surface area

$$W_s = \frac{t^3 \omega^2 B_0^2}{3\rho} \quad (6.72)$$

In deriving this expression we have implicitly assumed that the eddy currents are not strong enough to have a significant effect upon the strength of the magnetic field.

Equation (6.72) shows that the eddy-current losses depend very strongly on the thickness of the strip. This is the reason why transformer cores are made of thin strips or **laminations** of steel which are insulated from each other by a coating of lacquer. They are normally made of special steel which has a high resistivity because, as can be seen from Equation (6.72), this also helps to reduce the losses. The mean power loss also increases rapidly with increasing frequency. At radio-frequencies the losses in laminated iron cores are unacceptably high and magnetic oxides of iron known as **ferrites** are used instead because they have much higher resistivities.

6.14 Real electronic components

By this stage it should be apparent to the reader that the behaviour of real electronic components is much more complicated than that of the lumped resistors, capacitors and inductors used in circuit theory. Whenever current flows through a component a magnetic field is generated, so resistors and capacitors must have some self-inductance. The resistance in the winding of an inductor or transformer means that there must be some voltage drop across the device even under d.c. conditions. The existence of a potential difference between the different parts of the winding implies that there is some capacitance present. Although these parasitic effects can usually be neglected at low frequencies, they must be included in the circuit representations of the components at high frequencies.

6.15 Summary

In this chapter Faraday's law of electromagnetic induction has been introduced. It has been shown that an electromotive force can be induced in a circuit which has magnetic flux linked to it either by changing the area of the circuit or by changing the strength of the magnetic field. From this starting point the idea of inductance was introduced, so establishing another link between electric circuit parameters and electromagnetic field theory.

Stray inductances between parts of electronic circuits can produce unwanted coupling. The causes of electromagnetic interference were considered, and some cures suggested. The calculation of inductance was discussed using both direct calculation and energy methods. The latter are based on the idea of the stored energy associated with a magnetic field being distributed throughout the field. The analogy between L , C and R in two-dimensional problems was introduced as a way of deducing these parameters from each other.

The special case of energy storage in iron was discussed, leading to an expression for the work done in taking a sample of iron once around its hysteresis loop and to the idea of hysteresis loss. Finally, the consideration of the effects of a changing magnetic field on a solid conductor led to a discussion of eddy currents and of the losses associated with them.



Brain power

By 2020, wind could provide one-tenth of our planet's electricity needs. Already today, SKF's innovative know-how is crucial to running a large proportion of the world's wind turbines.

Up to 25 % of the generating costs relate to maintenance. These can be reduced dramatically thanks to our systems for on-line condition monitoring and automatic lubrication. We help make it more economical to create cleaner, cheaper energy out of thin air.

By sharing our experience, expertise, and creativity, industries can boost performance beyond expectations. Therefore we need the best employees who can meet this challenge!

The Power of Knowledge Engineering

Plug into The Power of Knowledge Engineering.
Visit us at www.skf.com/knowledge

SKF

7 Transmission lines

Objectives

- To introduce electromagnetic waves through a discussion of transmission lines as distributed circuits.
- To discuss the solutions to the wave equation for sinusoidal waves and pulses, and to introduce the idea of phase velocity.
- To explain the concept of characteristic impedance and its relationship to the power flow in the line.
- To explain the use of complex notation to describe waves.
- To show that a wave is reflected at the end of a line unless it is terminated by a load equal to its characteristic impedance.
- To introduce the terms ‘voltage reflection coefficient’ and ‘voltage standing wave ratio’.
- To show how impedances are transformed by a transmission line, and to introduce the idea of the quarter-wave transformer as a matching device.
- To consider the field description of a transmission line and to show how the phase velocity and characteristic impedance can be calculated.
- To derive expressions for the electric and magnetic fields in a coaxial cable and to consider how the power flow in the line may be calculated from them.

7.1 Introduction

Two-wire transmission lines appeared early in the history of the practical application of electricity with the advent of the electric telegraph. They are still an important means of transmitting both electrical power and information, although for the latter purpose they are now supplemented by radio and microwave links and optical fibres. The commonest forms of transmission line are parallel-wire and twisted-pair lines, used for electricity distribution and telephone connections, and coaxial cables, used for television aerial downloads and for interconnecting electronic instruments.

Throughout this book I have tried to show the links between the field and the circuit approaches to the description of electromagnetic phenomena. These provide alternative ways of dealing with problems. Electronic engineers are generally happiest when they are able to use circuit methods, with the properties of the components represented by equivalent circuits. Field theory provides an alternative to experimental measurements as a means of determining the equivalent circuit parameters. In this chapter, however, the field and circuit approaches draw even closer together. We shall see that the transmission of signals on transmission lines can be described in terms of propagation of electromagnetic waves. We shall also see that, when the dimensions of a circuit become comparable with the wavelength of these waves, elementary circuit theory breaks down.

7.2 The circuit theory of transmission lines

It was shown in Chapters 2 and 6 that a two-wire transmission line such as a coaxial cable has shunt capacitance and series inductance uniformly distributed along its length. At low frequencies it is usually possible to ignore these impedances and treat circuits as sets of lumped components connected together by wires whose length has no effect upon the operation of the circuit. We must now investigate the circumstances in which this approximation is not valid and the consequences for the design of electronic circuits.

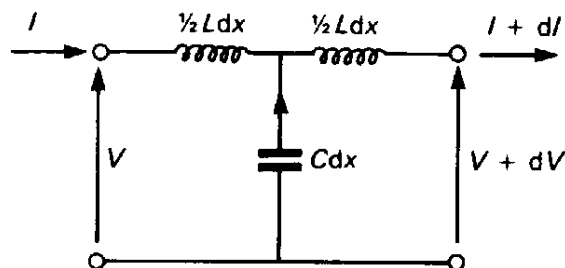

Fig. 7.1 The 'tee' network representing a short length dx of a transmission line having series inductance L per unit length and shunt capacitance C per unit length.

Figure 7.1 shows the circuit representation of an element of transmission line of length dx . If the line has inductance L per unit length and capacitance C per unit length, then the inductance and capacitance of the element must be $L dx$ and $C dx$.

The inductance has been divided into two so that the network is a symmetrical tee section. For the moment we assume that the whole line stretches to infinity in either direction, being made up of identical tee sections joined together in a cascade. If the voltage across the capacitor is V' , then

$$V' = V - \frac{1}{2} L \frac{dI}{dt} dx = V + dV + \frac{1}{2} L \frac{d}{dt} (I + dI) dx$$

When the second-order term $\frac{d(dI)}{dt}$ is neglected we obtain

$$\frac{\partial V}{\partial x} = -L \frac{\partial I}{\partial t} \tag{7.1}$$

The current through the capacitor is

$$dI = -C dx \frac{dV'}{dt}$$

To first order $V' = V$, so that

$$\frac{\partial I}{\partial x} = -C \frac{\partial V}{\partial t} \tag{7.2}$$

The pair of simultaneous differential equations (7.1) and (7.2) defines the relationship between the voltage and the current in the limit when the length (dx) of the element shrinks to zero and the line becomes completely uniform.

The current can be eliminated from these equations by differentiating Equation (7.1) with respect to x , and Equation (7.2) with respect to t , since

$$\frac{\partial^2 I}{\partial x \partial t} = \frac{\partial^2 I}{\partial t \partial x}$$

giving

$$\frac{\partial^2 V}{\partial x^2} = LC \frac{\partial^2 V}{\partial t^2} \quad (7.3)$$

Similarly, differentiating Equation (7.1) with respect to t and Equation (7.2) with respect to x , we get

$$\frac{\partial^2 I}{\partial x^2} = LC \frac{\partial^2 I}{\partial t^2} \quad (7.4)$$

Equations (7.3) and (7.4) are examples of the one-dimensional form of the **wave equation**. For sinusoidal waves their general solution has the form

$$V = V_1 \cos(\omega t \pm kx) + V_2 \sin(\omega t \pm kx) \quad (7.5)$$

and

$$I = I_1 \cos(\omega t \pm kx) + I_2 \sin(\omega t \pm kx) \quad (7.6)$$

where V_1 , V_2 , I_1 and I_2 are constants whose values are determined by the boundary conditions of the problem. Substituting these expressions into the wave equations shows that they are acceptable solutions provided that

$$k^2 = \omega^2 LC \quad (7.7)$$

The physical significance of these solutions can be discussed, without loss of generality, by considering the behaviour of the function

$$V = V_1 \cos(\omega t - kx) \quad (7.8)$$

The form of this function is shown in Fig. 7.2. The solid curve shows the variation of voltage with position along the line when $t = 0$. At a later time $t = t_1$ the wave has moved to the position shown by the broken line. This can be verified by noting that the first zero of the function is given by

$$\begin{aligned}(\omega t - kx) &= \frac{\pi}{2} \\ x &= \left(\frac{\omega t}{k}\right) - \left(\frac{\pi}{2k}\right)\end{aligned}\quad (7.9)$$

This equation shows that the zero crossing, and hence the whole wave, is moving in the positive x -direction with a constant velocity given by

$$v_p = \frac{\omega}{k}\quad (7.10)$$

This velocity is known as the **phase velocity** of the wave.

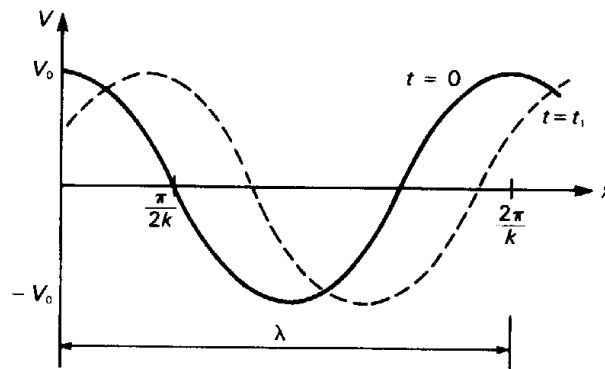

Fig. 7.2 The variation of the voltage along a transmission line, as given by Equation (7.8) for $t = 0$ and a later time $t = t_1$, showing how the wave moves steadily in the positive x -direction.

From Equation (7.7) we also have

$$v_p = \frac{1}{\sqrt{LC}}\quad (7.11)$$

Equation (6.60) shows that v_p depends only on the properties of the material between the conductors and not on their geometry.

The **propagation constant**, or **wavenumber**, k is related to the wavelength λ of the wave by

$$k = \frac{2\pi}{\lambda}\quad (7.12)$$

as can be seen from Fig. 7.2. If k is negative the phase velocity is also negative and the wave is travelling in the negative x -direction. This corresponds to the positive signs in Equation (7.5). The alternative solution, involving the sine function in place of the cosine, gives a wave which is shifted in phase by 90° .

By making a suitable choice of the constants V_1 and V_2 in Equation (7.5) we can make the amplitude and phase of the wave what we will. This is made clearer by a consideration of the alternative form of (7.5):

$$V = V_0 \cos(\omega t \pm kx + \phi) \quad (7.13)$$

where the amplitude V_0 and the phase ϕ are arbitrary constants whose values are to be determined by the boundary conditions. The equivalence of the two forms of the wave given in Equations (7.5) and (7.13) can be demonstrated by expanding the cosine function in Equation (7.13).

7.3 Representation of waves using complex numbers

In the theory of a.c. circuits 'j-notation' is an indispensable tool. Before proceeding to a discussion of the properties of transmission lines it is necessary to extend the notation to problems where the voltages and currents vary sinusoidally in distance as well as in time. To do this consider the voltage

$$V' = jV_1 \sin(\omega t - kx) - jV_2 \cos(\omega t - kx) \quad (7.14)$$

With us you can
shape the future.
Every single day.

For more information go to:
www.eon-career.com

Your energy shapes the future.

e-on



When this voltage is added to the general solution for the wave in the positive x -direction, obtained from Equation (7.5) by taking the negative signs, the result is

$$V = V_1[\cos(\omega t - kx) + j \sin(\omega t - kx)] - jV_2[\cos(\omega t - kx) + j \sin(\omega t - kx)]$$

or

$$V = V_1 \exp[j(\omega t - kx)] \quad (7.15)$$

where the amplitude of the wave \hat{V} is, in general, complex. It turns out that Equation (7.15) provides a more convenient form of representation for a wave than Equation (7.5), but it must be remembered that it is only the real part of Equation (7.15) which has physical significance.

Hence, whenever the form in Equation (7.15) is used to represent a wave in a problem it is implicit that, when an expression has been obtained as the solution to the problem, the real part of it is to be taken as having physical significance. It is easy to verify by substitution that Equation (7.15) is a solution of Equation (7.3). The two arbitrary constants in Equation (7.5) are present as the real and imaginary parts of V .

7.4 Characteristic impedance

So far we have discussed the propagation of waves on the line solely in terms of the voltage. The corresponding solution for the current can be obtained by substituting

$$V = V_1 \exp[j(\omega t - kx)] \quad \text{and} \quad I = I_1 \exp[j(\omega t - kx)]$$

into Equation (7.1), with the result

$$-jkV_1 = -j\omega L I_1$$

so that, making use of (7.7)

$$I_1 = \left(\frac{k}{\omega L} \right) V_1 = \frac{V_1}{Z_0} \quad (7.16)$$

where

$$Z_0 = \frac{\omega L}{k} = \sqrt{\frac{L}{C}} \quad (7.17)$$

This is a constant which has the dimensions of resistance. It is known as the **characteristic impedance** of the line. Equation (6.61) shows that Z_0 depends upon the geometry of the line and the properties of the material between the conductors. For the loss-less line considered here Z_0 is a real quantity, that is, a pure resistance, because the voltage and current are in phase with each other. It can be shown that if, on the other hand, the line has loss, then the voltage and current are no longer in phase with each other and, consequently, Z_0 has an inductive or capacitive component. The physical significance of the characteristic impedance becomes clearer when we consider the reflection of waves from the termination of the line.

7.5 Reflection of waves at the end of a line

Figure 7.3 shows a transmission line of characteristic impedance Z_0 which is terminated by an impedance Z at $x = 0$.

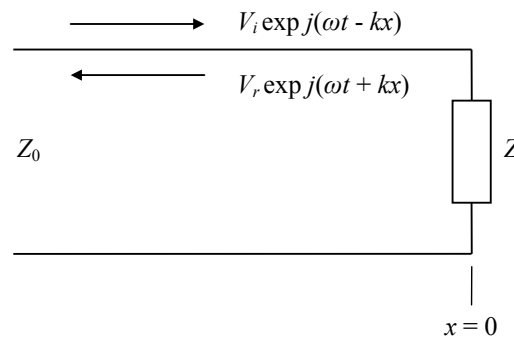

Fig. 7.3 A line of characteristic impedance Z_0 terminated by an impedance Z with incident and reflected waves having amplitudes V_i and V_r .

The wave incident on the termination is

$$V = V_i \exp[j(\omega t - kx)] \quad (7.18)$$

We must assume, until it has been shown otherwise, that some of the incident wave will be reflected as the wave

$$V = V_r \exp[j(\omega t + kx)] \quad (7.19)$$

The amplitudes V_i and V_r are complex. The corresponding currents are

$$I_i = \left(\frac{V_i}{Z_0} \right) \exp[j(\omega t - kx)] \quad (7.20)$$

and

$$I_r = - \left(\frac{V_r}{Z_0} \right) \exp[j(\omega t + kx)] \quad (7.21)$$

as can be shown by substituting the expressions for the incident and reflected voltage waves in Equation (7.16). We shall see later that the negative sign in Equation (7.21) indicates that the power in the reflected wave is travelling in the negative x -direction.

At $x = 0$ the voltage is

$$V = (V_i + V_r) \exp(j\omega t) \quad (7.22)$$

and the current is

$$I = \left(\frac{V_i - V_r}{Z_0} \right) \exp(j\omega t) \quad (7.23)$$

by adding together the voltages and currents for the incident and reflected waves.

But the ratio of the voltage to the current at $x = 0$ must equal the termination impedance Z . Therefore

$$Z = \frac{V_i + V_r}{V_i - V_r} Z_0 \quad (7.24)$$

© 2013 Accenture. All rights reserved.

be > your degree

Bring your talent and passion to a global organization at the forefront of business, technology and innovation. Discover how great you can be.

Visit accenture.com/bookboon

Be greater than.
consulting | technology | outsourcing

accenture
High performance. Delivered.

which can be rearranged to give

$$\frac{V_r}{V_i} = \frac{Z - Z_0}{Z + Z_0} = \Gamma \quad (7.25)$$

where Γ is known as the **voltage reflection coefficient**. Equation (7.25) shows that the amplitude of the reflected wave is zero when $Z = Z_0$. When this condition is satisfied the termination is said to be **matched** to the line.

When a line is terminated by a load equal to its characteristic impedance the instantaneous power absorbed in the termination is

$$W = VI = \left(\frac{|V_i|^2}{Z_0} \right) \cos^2(\omega t) \quad (7.26)$$

The mean power is obtained by averaging Equation (7.26) over one complete cycle, giving

$$\bar{W} = \frac{|V_i|^2}{2Z_0} \quad (7.27)$$

Since there is no reflected wave when $Z = Z_0$ it follows that \bar{W} is the mean power flow in the incident wave. This is the condition for maximum transfer of power from the incident wave to the load and it is a generalization of the Maximum Power Transfer Theorem of circuit theory.

If the load resistor were replaced by a semi-infinite section of transmission line having the same characteristic impedance there would still be no reflected wave in the part of the line to the left of $x = 0$. Thus the characteristic impedance is the input impedance of the semi-infinite line. Since we could just as well have replaced the load resistor by a section of line of finite length terminated by Z_0 without producing a reflected wave it follows that the input impedance of a transmission line terminated by its characteristic impedance is also Z_0 .

When the line is not terminated by its characteristic impedance the voltage at a general point on it is

$$V = V_i \exp[j(\omega t - kx)] + \Gamma V_i \exp[j(\omega t + kx)] \quad (7.28)$$

The amplitude of the voltage which would be measured at this point is

$$|V| = |V_i| |\exp(-jkx)| |1 + \Gamma \exp(2jkx)| = |V_i| |1 + \Gamma \exp(2jkx)| \quad (7.29)$$

since $|\exp(-jkx)| = 1$.

Equation (7.29) shows that the amplitude of the voltage varies along the line between the maximum and minimum values

$$V_{\max} = |V_i| (1 + |\Gamma|) \quad (7.30)$$

$$V_{\min} = |V_i| (1 - |\Gamma|) \quad (7.31)$$

The ratio of these two is easily measured with a sliding probe and a suitable detector. It is known as the **voltage standing wave ratio** (VSWR), and its value is given by

$$S = \frac{1 + |\Gamma|}{1 - |\Gamma|} \quad (7.32)$$

The probe, therefore, detects a signal whose amplitude varies periodically with position along the line as a standing wave. The wavelength of the standing wave observed is given by $2kx = 2\pi$ from Equation (7.29), that is

$$x = \frac{\lambda}{2} \quad (7.33)$$

where λ is the wavelength of the travelling waves.

7.6 Pulses on transmission lines

So far we have assumed that the signals propagating on the transmission lines are sinusoidal. It is, of course, possible to consider non-sinusoidal signals by using Fourier synthesis to construct them from sine waves of different frequencies. But pulses, which are important for digital data transmission, can most easily be studied directly. It is easy to show by substitution that any functions having the form

$$V = V_0 f(x - v_p t) \quad \text{and} \quad I = I_0 f(x - v_p t) \quad (7.34)$$

are solutions of Equations (7.1) to (7.4).

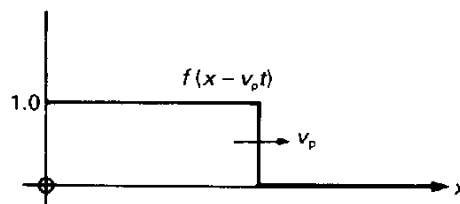

The function f can have any form, but for the study of pulses it is taken to be the step function shown in the figure on the right. This function is defined to be 0 for $(x - v_p t) > 0$ and 1 for $(x - v_p t) \leq 0$. Substituting the voltage and current given in Equation (7.34) into Equation (7.1) gives

$$V_0 f' = v_p L I_0 f'$$

where f' is the derivative of f so that, making use of Equations (7.11) and (7.17)

$$V_0 = Z_0 I_0 \quad (7.35)$$

as before.

Figure 7.4(a) shows a voltage source with internal impedance Z_s connected to a semi-infinite transmission line of characteristic impedance Z_0 . If the line is uncharged until the switch is closed at $t = 0$, then a wave having the form shown in Fig. 7.4(b) will propagate down the line with velocity v_p . As v_p is independent of frequency the step propagates without any change in its shape. A line for which this is true is said to be **non-dispersive**. Conversely, if v_p depends on frequency, the line is **dispersive**, the different Fourier components of the step travel at different speeds, and the shape of the step changes as it propagates.



"I studied English for 16 years but...
...I finally learned to speak it in just six lessons"
Jane, Chinese architect

ENGLISH OUT THERE

Click to hear me talking before and after my unique course download

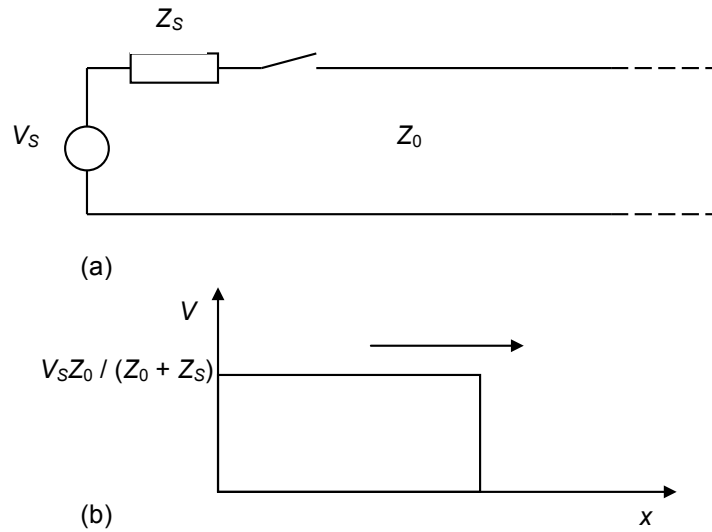

Fig. 7.4 A semi-finite transmission line of characteristic impedance Z_0 is connected to a source of impedance Z_s by a switch at $t = 0$. The result is a step voltage wave which travels down the transmission line as shown.

The voltage and current at the start of the line must satisfy Equation (7.35), so that

$$V_0 = \frac{Z_0}{Z_0 + Z_s} V_s \tag{7.36}$$

by the potential-divider rule.

7.7 Reflection of pulses at the end of a line

When a transmission line is terminated by a resistance R , part of an incident pulse is usually reflected. The voltage and current at any point on the line are given by

$$V = V_i + V_r \quad \text{and} \quad I = I_i + I_r = \frac{(V_i - V_r)}{Z_0}$$

To satisfy the boundary conditions at the termination

$$R = \frac{V}{I} = \frac{V_i + V_r}{V_i - V_r} Z_0$$

so that

$$\frac{V_r}{V_i} = \frac{R - Z_0}{R + Z_0} \tag{7.37}$$

From Equation (7.37) it is clear that there are three possible conditions:

1. $R > Z_0$: V_r is positive so that the reflected wave is added to the incident wave.
2. $R < Z_0$: V_r is negative and the reflected wave is subtracted from the incident wave.
3. $R = Z_0$: V_r is zero and the incident wave is completely absorbed by the termination.

Conditions (1) and (2) can be illustrated by the extreme cases of termination of a line by an open circuit and a short circuit. Figure 7.5 shows what happens when there is an open circuit. Figure 7.5(a) shows the situation just before the incident wave has reached the open circuit. When it reaches it a reflected wave is generated to satisfy the boundary conditions. From Equation (7.37) the amplitude of the reflected wave is equal to that of the incident wave. A short time later the situation is as shown in Fig. 7.5(b), with the reflected wave superimposed on the incident wave.

DUKE
THE FUQUA
SCHOOL
OF BUSINESS

BUSINESS HAPPENS
HERE.

www.fuqua.duke.edu/globalmba

Learn More >



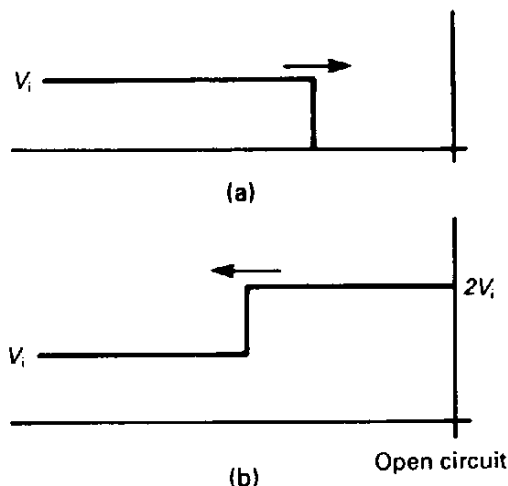

Fig. 7.5 The reflection of a step wave by an open circuit. The wave is shown (a) just before it reaches the end of the line, and (b) just after it has been reflected.

In the same way Fig. 7.6(a) shows a wave approaching a short circuit. This time the wave is inverted on reflection so that the sum of the wave amplitudes is always zero at the short circuit. A short time after the reflection of the wave the situation is as shown in Fig. 7.6(b).

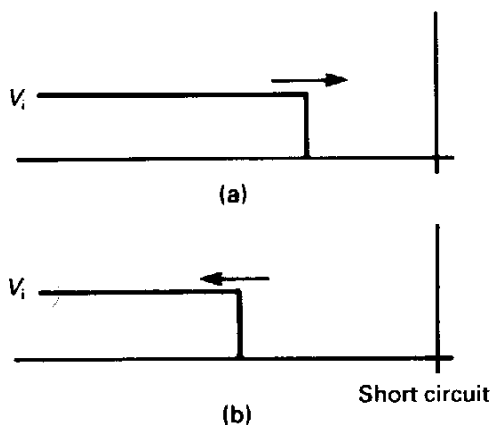

Fig. 7.6 The reflection of a step wave by a short circuit. The wave is shown (a) just before it reaches the end of the line, and (b) just after it has been reflected.

It is instructive to consider the effects of these reflections at the input of the transmission line. To make things simpler we will assume that the source is matched to the line so that $Z_s = Z_0$ as shown in Fig. 7.7(a). Figure 7.7(b) shows how the voltage at the start of the line varies with time when the termination is an open circuit. Initially $V_A = V_S/2$ as the source feeds current into the line to set up the incident wave. This wave travels down the line in time T . At time $2T$ the reflected wave returns to A so that $V_A = V_S$. The reflected wave is completely absorbed by the source impedance, so no further change takes place and the line is charged to the full source voltage.

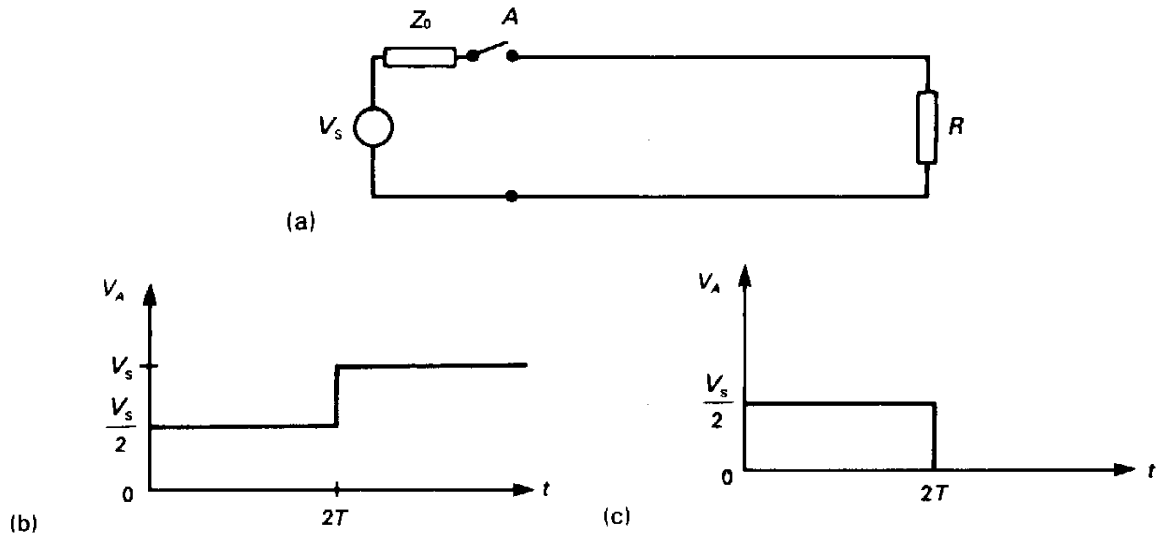

Fig. 7.7 Variation of the voltage at the input of a transmission line with time. The line has characteristic impedance Z_0 , and is connected to a matched source and to a mis-matched load. When the termination is an open circuit the voltage varies as shown in (b). (c) shows what happens when R is a short circuit.

If the line is terminated by a short circuit the voltage varies with time, as shown in Fig. 7.7(c). There is an initial period when the voltage at A is not zero, but this is cancelled at time $2T$ by the return of the reflected wave. According to elementary circuit theory the voltages would take their final values as soon as the switch was closed. The true situation can be described by saying that, until the return of the reflected wave, the source has no information about the magnitude of the terminating impedance. The step cannot travel faster than the speed of light, so it always takes a finite time for the system to reach a steady state.

The transmission of a short pulse along a line can be investigated by considering the superposition of positive and negative step functions separated by a short interval of time.

7.8 Transformation of impedance along a transmission line

Consider a transmission line having characteristic impedance Z_0 which is terminated at $x = 0$ by an impedance Z_t (see Fig. 7.8). At the point on the line which is l from the load, $x = -l$ and the voltage is given by

$$V = V_i \exp[j(\omega t + kl)] + \Gamma V_i \exp[j(\omega t - kl)] \tag{7.38}$$

The corresponding expression for the current is

$$I = \left(\frac{V_i}{Z_0}\right) \exp[j(\omega t + kl)] - \Gamma \left(\frac{V_i}{Z_0}\right) \exp[j(\omega t - kl)] \tag{7.39}$$

where

$$\Gamma = \frac{Z_L - Z_0}{Z_L + Z_0} \quad (7.40)$$

from Equation (7.25).

The apparent impedance at this point on the line is given by

$$Z'_L = \frac{V}{I} = \frac{\exp(jkl) + \Gamma \exp(-jkl)}{\exp(jkl) - \Gamma \exp(-jkl)} Z_0 \quad (7.41)$$

After substituting for Γ and rearranging, we get

$$\begin{aligned} \frac{Z'_L}{Z_0} &= \frac{Z_L [\exp(jkl) + \exp(-jkl)] + Z_0 [\exp(jkl) - \exp(-jkl)]}{Z_L [\exp(jkl) - \exp(-jkl)] + Z_0 [\exp(jkl) + \exp(-jkl)]} \\ &= \frac{Z_L \cos(kl) + jZ_0 \sin(kl)}{Z_0 \cos(kl) + jZ_L \sin(kl)} \\ &= \frac{Z_L + jZ_0 \tan(kl)}{Z_0 + jZ_L \tan(kl)} \end{aligned} \quad (7.42)$$

Join American online LIGS University!

Interactive Online programs
BBA, MBA, MSc, DBA and PhD

Special Christmas offer:

- ▶ enroll **by December 18th, 2014**
- ▶ **start studying and paying only in 2015**
- ▶ **save up to \$ 1,200** on the tuition!
- ▶ Interactive Online education
- ▶ visit ligsuniversity.com to find out more!

Note: LIGS University is not accredited by any nationally recognized accrediting agency listed by the US Secretary of Education. More info [here](#).



Click on the ad to read more

This is a very important result. It shows that if the length l of the transmission line is of the same order of magnitude as the wavelength ($2\pi/k$), or greater, then the apparent impedance at the input of the line is not normally equal to the load impedance. The usual assumption of circuit theory is that the impedances are independent of the lengths of the connecting wires. We now see that this is just the limit of Equation (7.42) when kl tends to zero.

The significance of Equation (7.42) can be explained in a slightly different way by considering Fig. 7.8. This shows two transmission lines, one of which is longer than the other by l . The longer line is terminated by a load Z_L and the shorter by Z'_L , where Z'_L is given by Equation (7.42). At the plane A-A the impedance presented to the incident wave is the same on both lines. Thus the reflected wave to the left of A-A must have the same amplitude and phase on both lines. It follows that Z_L and Z'_L must reflect the incident wave with the same amplitude but with a phase difference of $\exp(2jkl)$, since that is the phase change from A-A to Z_L and back.

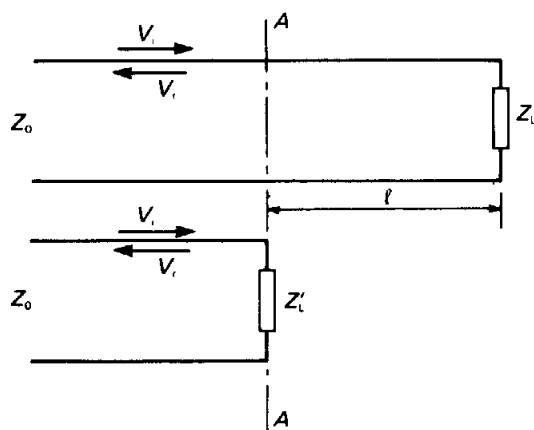

Fig. 7.8 The apparent terminating impedance of a transmission line varies with position along the line. If two lines are terminated by Z_L and Z'_L as calculated from Equation (7.42), then the amplitude and phase of the reflected wave to the left of the plane A-A is the same on both lines.

The quarter-wave transformer

A case of considerable practical importance is obtained when the line is exactly one quarter of a wavelength long. Setting $kl = \pi/2$ in Equation (7.42) gives

$$\frac{Z'_L}{Z_0} = \frac{Z_0}{Z_L}$$

or

$$Z_0^2 = Z_L Z'_L \tag{7.43}$$

This result allows us to match a load to a line by inserting a short section of a line, having a different impedance, between them, as shown in Fig. 7.11. The short length of line must be a quarter wavelength long, and it must have the characteristic impedance given by (7.43). The same technique can be used to ensure a match between two transmission lines which have different impedances.

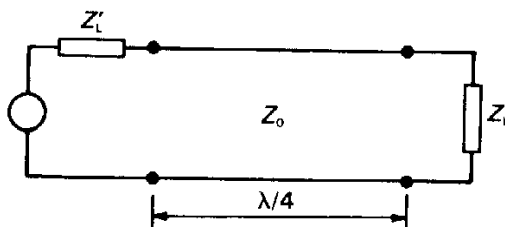

Fig. 7.9 A source of impedance Z'_L can be matched to a load of impedance Z_L by using a quarter wavelength of a transmission line whose characteristic impedance is $Z_0 = \sqrt{Z_L Z'_L}$ as a transformer.

The quarter-wave transformer suffers from the difficulty that it works exactly only at a single frequency. This problem can be overcome by cascading a number of quarter-wave transformers to produce a broad-band match.

Two special cases arise when the terminating impedance of the transformer is either an open circuit or a short circuit. If there is an open circuit, then $Z_L = \infty$ and (7.42) becomes

$$\frac{Z'_L}{Z_0} = \frac{1}{j \tan(kl)}$$

so that Z'_L tends to zero as kl tends to $\pi/2$. Thus a quarter-wave transformer transforms an open circuit into a short circuit. The converse is also true. If the termination of the transformer is a short circuit, then the impedance at its input tends to infinity. In either case there is a total reflection of the incident power.

7.9 The coaxial line

The simplest practical transmission line from the field point of view is the coaxial cable. We shall therefore take it as the example to be discussed, but the methods applied, and the conclusions reached, are applicable to all types of uniform two-wire line. A typical cable has a solid copper inner conductor and a braided outer conductor separated by a uniform cylindrical layer of polythene. To make the problem tractable we assume that the braided outer conductor can be represented with sufficient accuracy by a continuous conducting cylinder. Taking the radii of the inner and outer conductors as a and b , respectively, we recall that the capacitance per unit length is given by (6.50)

$$C = \frac{2\pi\epsilon}{\ln\left(\frac{b}{a}\right)} \tag{7.44}$$

and the inductance per unit length is given by (6.37)

$$L = \frac{\mu_0}{2\pi} \ln\left(\frac{b}{a}\right) \quad (7.45)$$

Substituting these expressions for C and L into Equations (7.11) and (7.17) we get

$$v_p = \frac{1}{\sqrt{\epsilon\mu_0}} \quad (7.46)$$

and

$$Z_0 = \frac{1}{2\pi} \sqrt{\frac{\mu_0}{\epsilon}} \ln\left(\frac{b}{a}\right) \quad (7.47)$$

A very interesting result is obtained for the special case of an air-spaced line when

$$\begin{aligned} v_p &= 1/\sqrt{\epsilon_0\mu_0} \\ &= (8.854 \times 10^{-12} \times 4\pi \times 10^{-7})^{-\frac{1}{2}} \\ &= 0.2998 \times 10^9 \text{ ms}^{-1} \end{aligned}$$

ie business school

#1 EUROPEAN BUSINESS SCHOOL
FINANCIAL TIMES 2013

#gobeyond

MASTER IN MANAGEMENT

Because achieving your dreams is your greatest challenge. IE Business School's Master in Management taught in English, Spanish or bilingually, trains young high performance professionals at the beginning of their career through an innovative and stimulating program that will help them reach their full potential.

- Choose your area of specialization.
- Customize your master through the different options offered.
- Global Immersion Weeks in locations such as Rio de Janeiro, Shanghai or San Francisco.

Because you change, we change with you.

www.ie.edu/master-management | mim.admissions@ie.edu | f t in YouTube U

which is the experimental value for the velocity of light in free space. This suggests the existence of a link between electromagnetism and optics, and the possibility that light is an electromagnetic phenomenon. Since the relative permittivity of any medium is greater than unity, it follows that the phase velocity of the waves on a transmission line is always less than or equal to the velocity of light.

7.10 The electric and magnetic fields in a coaxial line

To find expressions for the electric and magnetic fields within a coaxial line which is carrying a wave along it we apply Gauss' theorem and the magnetic circuit law. This approach involves us in making some assumptions about the fields in the line. Taking the electric field first, we assume that, as in the electrostatic case, only the radial component is present. The charge per unit length on the centre conductor is given by

$$q = CV_0 \exp[j(\omega t - kz)] \quad (7.48)$$

so, applying Gauss' theorem

$$E_r = \frac{q}{2\pi\epsilon r} = \frac{CV_0}{2\pi\epsilon} \frac{1}{r} \exp[j(\omega t - kz)]$$

Substituting for the capacitance per unit length from Equation (7.44) gives

$$E_r = \frac{V_0}{\ln(b/a)} \frac{1}{r} \exp[j(\omega t - kz)] \quad (7.49)$$

The magnetic field is given by

$$H_\theta = \frac{I}{2\pi r} = \frac{1}{2\pi r} \frac{V_0}{Z_0} \exp[j(\omega t - kz)]$$

Substituting for Z_0 from Equation (7.47)

$$H_\theta = \sqrt{\frac{\epsilon}{\mu_0}} \frac{V_0}{\ln(b/a)} \frac{1}{r} \exp[j(\omega t - kz)] = \sqrt{\frac{\epsilon}{\mu_0}} E_r \quad (7.50)$$

These fields are shown in Fig. 7.10. We note that the ratio of the strengths of the electric and magnetic fields is

$$\frac{E_r}{H_\theta} = \sqrt{\frac{\mu_0}{\epsilon}} = Z_w \quad (7.51)$$

This quantity, which depends only upon the properties of the material filling the line, has the dimensions of resistance. It is known as the **wave impedance** of the wave.

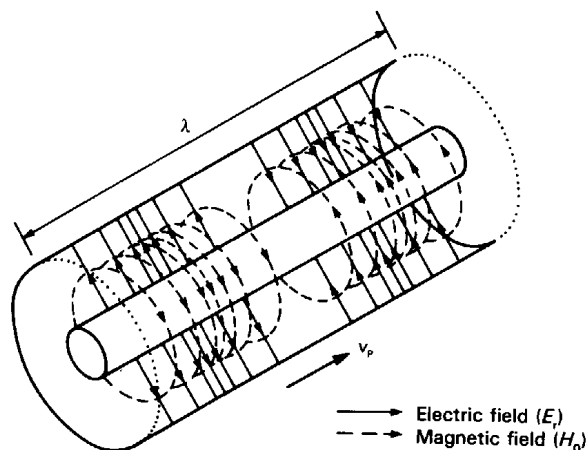

Fig. 7.10 The electromagnetic field in one wavelength of a coaxial line showing the directions of the electric and magnetic fields and the direction of propagation of the wave. Half of the outer conductor has been removed for clarity. The electric field lines are shown schematically; they actually radiate equally in all directions.

Although these results have been derived by making assumptions about the directions of the fields, they are confirmed by more rigorous analysis. It is found that, for any two-wire transmission line, the electric and magnetic field vectors are perpendicular to each other and to the direction of propagation of the wave. Such waves are known as transverse electric and magnetic (TEM) waves.

7.11 Power flow in a coaxial line

When discussing the storage of energy in capacitors and inductors we saw that it is sometimes useful to think of the energy as being distributed throughout the electric or magnetic fields. In the same way we can think of the power flowing down a coaxial cable as being distributed throughout the field. At any point the electric energy density is

$$w_E = \frac{1}{2} \mathbf{D} \cdot \mathbf{E} = \frac{1}{2} \epsilon E_r^2 \tag{7.52}$$

while the magnetic energy density is

$$w_M = \frac{1}{2} \mathbf{B} \cdot \mathbf{H} = \frac{1}{2} \mu_0 H_\theta^2 \tag{7.53}$$

Making use of Equation (7.51) we can write the total energy density as

$$w = w_E + w_M = \frac{1}{2} \epsilon E_r^2 + \frac{1}{2} \mu_0 \left(\frac{\epsilon}{\mu_0} E_r^2 \right) = \epsilon E_r^2 \tag{7.54}$$

Now at any point within the line the fields vary sinusoidally with time. Therefore the time average of the stored energy is

$$\bar{w} = \frac{1}{2} \epsilon E_r^2 = \frac{\epsilon V_0^2}{2(\ln(b/a))^2 r^2} \tag{7.55}$$

The whole field pattern is moving in the positive z direction with velocity v_p , so the power density is

$$S = \bar{w} v_p = \frac{1}{2} E_r (\varepsilon v_p E_r) = \frac{1}{2} E_r H_\theta \quad (7.56)$$

making use of Equations (7.46) and (7.51). We shall see in Chapter 8 that this is an example of the application of a more general result relating to the power flow in electromagnetic waves.

To check the equivalence of the field and circuit descriptions of the problem we can calculate the total power flow by integrating Equation (7.56) over the space between the conductors. Then

$$P = \int_a^b \frac{\varepsilon v_p V_0^2}{2(\ln(b/a))^2} \frac{2\pi r}{r^2} dr \quad (7.57)$$

$$P = \frac{1}{2} V_0^2 \sqrt{\frac{\varepsilon}{\mu_0}} \frac{2\pi}{\ln(b/a)} = \frac{V_0^2}{2Z_0} \quad (7.58)$$

from the expression for Z_0 given in Equation (7.47), so the power is identical to that calculated by circuit methods (Equation (7.27)).

SMS from your computer

...Sync'd with your Android phone & number

Go to

BrowserTexting.com

and start texting from your computer!

BrowserTexting

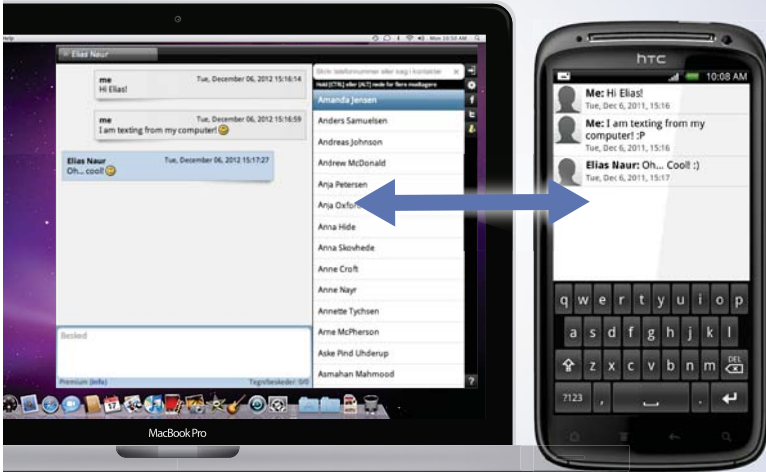

7.12 Summary

In this chapter transmission lines have been introduced through a discussion of distributed circuits. The voltages and currents were found to be governed by the wave equation, and it was demonstrated that solutions could be found which could be interpreted as travelling waves. The power carried by these waves was expressed in terms of the voltage on the line and its characteristic impedance.

It was demonstrated that, unless a line is matched by being terminated by a load equal to its characteristic impedance, some of the power in a wave incident upon the termination is reflected back down the line. This reflection produces a partial standing wave on the line. The effect of the reflected wave is to make the input impedance of a line depend upon its length as well as upon the terminating impedance. Thus it was shown that, at high frequencies when the lengths of lines are comparable with the wavelengths of the signals on them, it is no longer possible to treat circuits in terms of lumped components connected together by wires of arbitrary length. The transformation of impedance by a short length of a transmission line is put to use in the quarter wave transformer to match a load to a line.

It is also important for lines to be correctly matched when the signals are in the form of short pulses. Incorrect matching results in reflections of the pulses. If a line is not matched at both ends multiple reflections can occur so that a whole train of pulses is produced by transmitting a single pulse down the line.

Transmission lines were also considered from the point of view of the electric and magnetic fields within them. It was shown that the phase velocity and characteristic impedance of a line at a given frequency can be calculated from field considerations. Expressions were found for the electric and magnetic fields within a coaxial line, and it was demonstrated that the flow of power down the line could be regarded as that of an electromagnetic wave propagating in the space between the conductors. It was found that, for an air-spaced line, this wave propagates with a phase velocity equal to the speed of light. The equivalence between the circuit and field approaches to the description of waves on transmission lines was demonstrated by showing that both give the same expression for the power flow.

8 Maxwell's equations and electromagnetic waves

Objectives

- To show how Maxwell removed an inconsistency in the magnetic circuit law by introducing the idea of the displacement current.
- To derive the differential forms of the magnetic circuit law and Faraday's law, and to introduce the curl of a vector.
- To present Maxwell's equations in both integral and differential form.
- To demonstrate how the existence of plane electromagnetic waves in free space can be deduced from Maxwell's equations.
- To show that the power flow in an electromagnetic field can be calculated by integrating the Poynting vector over a closed surface.

8.1 Introduction

In Chapter 7 we saw how it is possible for electromagnetic waves to propagate along a transmission line such as a coaxial cable. We shall now proceed to show that electromagnetic waves can exist independently of any system of conductors and can travel through free space. This conclusion was first published by James Clerk Maxwell in 1873. The set of equations which bears his name forms a summary of all the topics treated in this book and demonstrates the symmetry and unity of electromagnetic theory. At the same time they are the foundation upon which modern electromagnetic theory is built. We are now so accustomed to the presence of radio, television, mobile phones and radar in the world that it is hard to realize how great Maxwell's contribution was to the understanding of the theory of electromagnetism. In his own day his theory was regarded as quite outrageous by many until its validity was demonstrated by Hertz's experiments some fifteen years later.

8.2 Maxwell's form of the magnetic circuit law

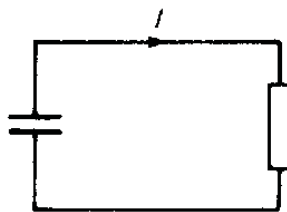

Maxwell noticed that, under certain circumstances, the magnetic circuit law in the form derived in Chapter 4 can give inconsistent results. This is readily demonstrated by considering the circuit shown in the figure on the right – a charged capacitor discharging through a resistor.

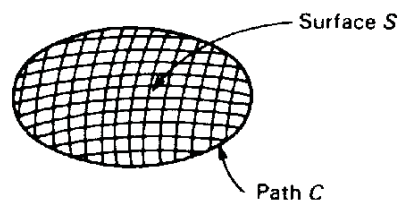

To apply the magnetic circuit law we must define a closed path C which encircles the wire and an open surface S which spans that path as a soap film can span a loop of wire. The figure in the margin attempts to show what is meant. If S is chosen so that it passes through the wire, then no problem arises and the magnetic field satisfies Equation (5.7), which is repeated here for convenience:

$$\oint_C \mathbf{H} \cdot d\mathbf{l} = \iint_S \mathbf{J} \cdot d\mathbf{A} \quad (8.1)$$

But, if the surface S is chosen so that it passes between the plates of the capacitor, then $\mathbf{J} = 0$, implying that the line integral of \mathbf{H} around C is also zero. This sounds nonsense! We expect the magnetic field around the circuit to be independent of the details of the means by which it has been calculated.

To resolve this difficulty we consider two different surfaces S_1 and S_2 which both span C , as shown in Fig. 8.1, and which together form a closed surface.

The Wake

the only emission we want to leave behind

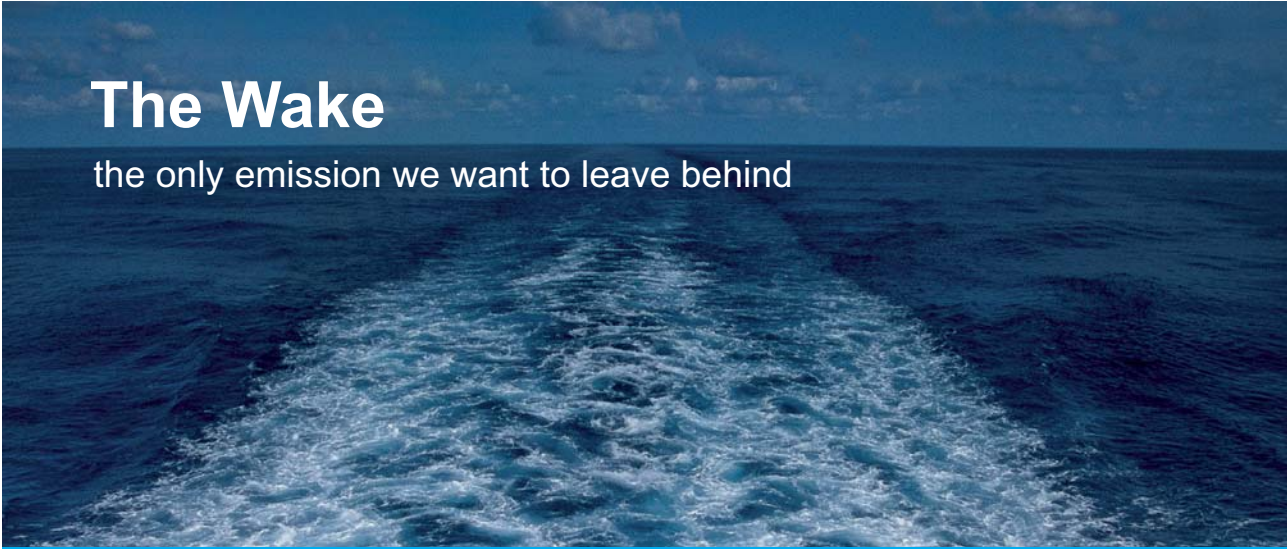

[Low-speed Engines](#) [Medium-speed Engines](#) [Turbochargers](#) [Propellers](#) [Propulsion Packages](#) [PrimeServ](#)

The design of eco-friendly marine power and propulsion solutions is crucial for MAN Diesel & Turbo. Power competencies are offered with the world's largest engine programme – having outputs spanning from 450 to 87,220 kW per engine. Get up front! Find out more at www.mandieselturbo.com

Engineering the Future – since 1758.

MAN Diesel & Turbo





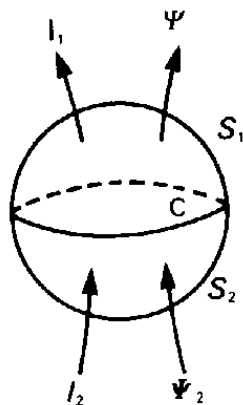

Fig. 8.1 Maxwell showed that the conduction current (I) passing through a closed loop (C) can be dependent upon the choice of the surface (S) over which it is calculated. The sum of the conduction and displacement currents ($I + d\Psi/dt$) is independent of the choice of surface.

At a particular instant let the total charge enclosed within this surface be Q , and let currents I_1 and I_2 cross the two surfaces as shown. Now charge must be conserved, so the rate of change with time of the charge enclosed must be equal to the net current flow into the volume enclosed. That is,

$$I_2 - I_1 = \frac{dQ}{dt} \tag{8.2}$$

If we define Ψ_1 to be the flux of \mathbf{D} through S_1 and Ψ_2 that through S_2 , as shown in Fig. 8.1, then the application of Gauss' theorem gives

$$\Psi_1 - \Psi_2 = Q \tag{8.3}$$

Differentiating Equation (8.3) with respect to time and substituting for dQ/dt in Equation (8.2) gives

$$I_1 + \frac{d\Psi_1}{dt} = I_2 + \frac{d\Psi_2}{dt} \tag{8.4}$$

This equation shows that the quantity $(I + d\Psi/dt)$ is independent of the choice of the position of the surface S even when I is not. This quantity is known as the **total current**, and $d\Psi/dt$ is known as the **displacement current**.

When the current density on the right-hand side of Equation (8.1) is replaced by the total current density $(\mathbf{J} + d\mathbf{D}/dt)$, the result is the equation

$$\oint_C \mathbf{H} \cdot d\mathbf{l} = \iint_S \left(\mathbf{J} + \frac{d\mathbf{D}}{dt} \right) \cdot d\mathbf{A} \tag{8.5}$$

This form of the magnetic circuit law is universally true.

8.3 The differential form of the magnetic circuit law

In Chapter 1 we saw that it is possible to express Gauss' theorem in either an integral form (Equation (1.5)) or a differential form (Equation (1.9)). The differential form turns out to be the more useful of the two because it enables a wider range of problems to be solved. The same is true of the magnetic circuit law, as we shall see.

To derive the differential form of Equation (8.5) we apply it to the small rectangular path $ABCD$ shown in Fig. 8.2. The surface S is taken to be in the y - z plane. The line integral of \mathbf{H} is taken around $ABCD$ in a direction which is in the right-handed corkscrew sense with respect to the positive x -direction. In other words, the elementary loop is encircled in the direction $ABCD$.

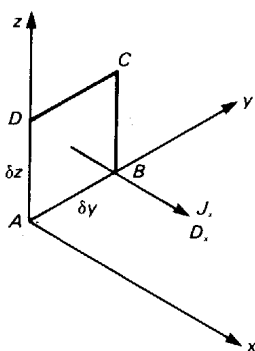

Fig. 8.2 The differential form of the magnetic circuit law can be derived by considering the line integral of the magnetic field around the infinitesimal loop $ABCD$.

The value of the line integral of \mathbf{H} around the loop is computed by considering each side in turn. The effect of the dot product of \mathbf{H} with $d\mathbf{l}$ is to pick out the component of \mathbf{H} which is parallel to the path. Thus, for AB we get

$$\int_A^B \mathbf{H} \cdot d\mathbf{l} = H_y \delta y \tag{8.6}$$

Along CD the y -component of \mathbf{H} can be written $(H_y + (\partial H_y / \partial z) \delta z)$, so that

$$\int_C^D \mathbf{H} \cdot d\mathbf{l} = \left(H_y + \left(\frac{\partial H_y}{\partial z} \right) \delta z \right) (-\delta y) \tag{8.7}$$

The minus sign on the right-hand side of this equation is there because the path CD is traversed in the negative y -direction.

Combining Equations (8.6) and (8.7) gives

$$\int_A^B \mathbf{H} \cdot d\mathbf{l} + \int_C^D \mathbf{H} \cdot d\mathbf{l} = -\frac{\partial H_y}{\partial z} \delta y \delta z \tag{8.8}$$

Applying the same argument to the other two sides of the loop gives

$$\int_B^C \mathbf{H} \cdot d\mathbf{l} + \int_D^A \mathbf{H} \cdot d\mathbf{l} = \frac{\partial H_z}{\partial y} \delta y \delta z \quad (8.9)$$

The complete line integral around the loop $ABCD$ is found by adding Equations (8.8) and (8.9) to give

$$\oint \mathbf{H} \cdot d\mathbf{l} = \left(\frac{\partial H_z}{\partial y} - \frac{\partial H_y}{\partial z} \right) \delta y \delta z \quad (8.10)$$

Since the loop is small, it is reasonable to assume that \mathbf{J} and \mathbf{D} are constant over it, so that the integral on the right-hand side of Equation (8.5) becomes

$$\iint \left(\mathbf{J} + \frac{\partial \mathbf{D}}{\partial t} \right) \cdot d\mathbf{A} = \left(J_x + \frac{\partial D_x}{\partial t} \right) \delta y \delta z \quad (8.11)$$

This time the dot product picks out the components of \mathbf{J} and \mathbf{D} which are normal to the plane of the loop because the vector area $d\mathbf{A}$ is also normal to the plane of the loop.

Equating Equations (8.10) and (8.11) yields the differential form of Equation (8.5) for the x -direction:

$$\frac{\partial H_z}{\partial y} - \frac{\partial H_y}{\partial z} = J_x + \frac{\partial D_x}{\partial t} \quad (8.12)$$

TURN TO THE EXPERTS FOR SUBSCRIPTION CONSULTANCY

Subscribe is one of the leading companies in Europe when it comes to innovation and business development within subscription businesses.

We innovate new subscription business models or improve existing ones. We do business reviews of existing subscription businesses and we develop acquisition and retention strategies.

Learn more at [linkedin.com/company/subscribe](https://www.linkedin.com/company/subscribe) or contact
Managing Director Morten Suhr Hansen at mha@subscribe.dk

SUBSCRIBE - to the future

Similar equations can be obtained for the other two coordinate directions:

$$\frac{\partial H_x}{\partial z} - \frac{\partial H_z}{\partial x} = J_y + \frac{\partial D_y}{\partial t} \quad (8.13)$$

$$\frac{\partial H_y}{\partial x} - \frac{\partial H_x}{\partial y} = J_z + \frac{\partial D_z}{\partial t} \quad (8.14)$$

Equations (8.12) to (8.14) together form the differential version of Equation (8.5) expressed in terms of the components of the vectors.

As usual, it is possible to write these equations in a more compact form by using vector notation. To do this we multiply each by the appropriate unit vector and add them together to give

$$\left(\frac{\partial H_z}{\partial y} - \frac{\partial H_y}{\partial z} \right) \hat{\mathbf{x}} + \left(\frac{\partial H_x}{\partial z} - \frac{\partial H_z}{\partial x} \right) \hat{\mathbf{y}} + \left(\frac{\partial H_y}{\partial x} - \frac{\partial H_x}{\partial y} \right) \hat{\mathbf{z}} = \mathbf{J} + \frac{\partial \mathbf{D}}{\partial t} \quad (8.15)$$

The left-hand side of this equation is known as the curl of \mathbf{H} and can be written as a determinant:

$$\text{curl } \mathbf{H} = \begin{vmatrix} \hat{\mathbf{x}} & \hat{\mathbf{y}} & \hat{\mathbf{z}} \\ \frac{\partial}{\partial x} & \frac{\partial}{\partial y} & \frac{\partial}{\partial z} \\ H_x & H_y & H_z \end{vmatrix} \quad (8.16)$$

which can be recognized as the vector product of the vector operator ∇ and the vector \mathbf{H} . Thus Equation (8.15) can be written succinctly in the form

$$\nabla \wedge \mathbf{H} = \mathbf{J} + \frac{\partial \mathbf{D}}{\partial t} \quad (8.17)$$

Like the other differential forms derived earlier, Equation (8.17) is actually valid for coordinate systems other than the rectangular Cartesian system used to derive it.

8.4 The differential form of Faraday's law

The general integral form of Faraday's law was shown to be

$$\oint \mathbf{E} \cdot d\mathbf{l} = - \iint \frac{\partial \mathbf{B}}{\partial t} \cdot d\mathbf{A} \quad (8.18)$$

(Equation (6.18)) for the case when the circuit is fixed in space and the magnetic flux density is changing with time.

So far we have assumed that the line integral of \mathbf{E} is to be taken around a loop of wire. But if the loop is open-circuited and the potential difference between its ends is measured with a high-impedance volt-meter, then the loop can be thought of as a device for measuring the value of the line integral of an electric field which exists in space whether the wire is present or not. Thus Equation (8.18) can be regarded as a generalization of Faraday's law, implying that, if there is a changing magnetic field in any region of space, then there is also an electric field there. This is, strictly speaking, a plausible guess rather than a deduction, but it is one whose validity has been demonstrated by the correctness of the results derived from it.

Making a comparison between Equations (8.5) and (8.18) allows us to deduce straight away that the differential form of (8.18) must be

$$\nabla \wedge \mathbf{E} = -\frac{\partial \mathbf{B}}{\partial t} \quad (8.19)$$

8.5 Maxwell's equations

We have now introduced all the principles of electromagnetism and it is convenient to gather the main results together. Taking the integral forms first they are:

Gauss' theorem in electrostatics (Equation (2.5))

$$\oiint \mathbf{D} \cdot d\mathbf{S} = \iiint \rho \, dv \quad (8.20)$$

Gauss' theorem in magnetostatics (Equation (4.15))

$$\oiint \mathbf{B} \cdot d\mathbf{A} = 0 \quad (8.21)$$

The magnetic circuit law (Equation (8.5))

$$\oint \mathbf{H} \cdot d\mathbf{l} = \iint \left(\mathbf{J} + \frac{d\mathbf{D}}{dt} \right) \cdot d\mathbf{A} \quad (8.22)$$

Faraday's law of induction (Equation (6.18))

$$\oint \mathbf{E} \cdot d\mathbf{l} = -\iint \frac{\partial \mathbf{B}}{\partial t} \cdot d\mathbf{A} \quad (8.23)$$

The corresponding differential forms are

$$(2.6) \quad \nabla \cdot \mathbf{D} = \rho \quad (8.24)$$

$$(4.16) \quad \nabla \cdot \mathbf{B} = 0 \quad (8.25)$$

$$(8.17) \quad \nabla \wedge \mathbf{H} = \mathbf{J} + \frac{\partial \mathbf{D}}{\partial t} \quad (8.26)$$

$$(8.19) \quad \nabla \wedge \mathbf{E} = -\frac{\partial \mathbf{B}}{\partial t} \quad (8.27)$$

These four equations form a summary of the whole of fundamental electro-magnetic theory. They are known, collectively, as **Maxwell's equations** and are the starting point for the discussion of all the more advanced topics in electro-magnetism.

In order to make use of them we also need a number of other equations which have been introduced in previous chapters. First there is the continuity equation

$$(3.14) \quad \nabla \cdot \mathbf{J} = -\frac{\partial \rho}{\partial t} \quad (8.28)$$

wethrive.net

How to retain your top staff
FIND OUT NOW FOR FREE

DO YOU WANT TO KNOW:

- What your staff really want?
- The top issues troubling them?
- How to make staff assessments work for you & them, painlessly?

Get your free trial
Because happy staff get more done

Then there are the **constitutive relations** which introduce the properties of materials, albeit in an idealized form. These are:

$$(2.4) \quad \mathbf{D} = \varepsilon \mathbf{E} \quad (8.29)$$

$$(3.3) \quad \mathbf{J} = \sigma \mathbf{E} \quad (8.30)$$

$$(5.5) \quad \mathbf{B} = \mu \mathbf{H} \quad (8.31)$$

The application of Equations (8.24) to (8.31) is most easily accomplished by making use of the methods of vector calculus. These techniques lie beyond the scope of this book, but a simple example of the use of Maxwell's equations which can be dealt with using more elementary mathematical methods is the subject of the next section.

8.6 Plane electromagnetic waves in free space

In the previous chapter we saw that electromagnetic waves can propagate along a coaxial line and that the electric field vector, the magnetic field vector, and the direction of propagation are all mutually perpendicular. Taking our clue from this, we can see whether Maxwell's equations indicate that similar waves can propagate in free space far from any material boundaries.

Let us assume that the wave propagates in the z -direction, and that the electric field has a component only in the x -direction. We assume, furthermore, that the intensity of the electric field varies only in the z -direction. Then from Equation (8.27), making use of the definition of the curl of a vector given in Equation (8.16), we have

$$\hat{\mathbf{y}} \frac{\partial E_x}{\partial z} = -\frac{\partial \mathbf{B}}{\partial t} \quad (8.32)$$

since all the other components of $\nabla \times \mathbf{E}$ are zero. This equation shows that the magnetic field vector must lie in the y -direction, at right angles to both the electric field and the direction of propagation. Thus Equation (8.32) can be written as a scalar equation

$$\frac{\partial E_x}{\partial z} = -\frac{\partial B_y}{\partial t} \quad (8.33)$$

In free space the conduction current $\mathbf{J} = 0$, so Equation (8.26) becomes

$$-\frac{\partial H_y}{\partial z} = \frac{\partial D_x}{\partial t} \quad (8.34)$$

The magnetic field terms can be eliminated between these two equations by differentiating the first with respect to z and the second with respect to t , and by making use of Equations (8.29) and (8.31) with $\varepsilon = \varepsilon_0$ and $\mu = \mu_0$. The result is that

$$\frac{\partial^2 E_x}{\partial z^2} = -\mu_0 \frac{\partial^2 H_y}{\partial z \partial t} = \varepsilon_0 \mu_0 \frac{\partial^2 E_x}{\partial t^2} \quad (8.35)$$

That is

$$\frac{\partial^2 E_x}{\partial z^2} = \frac{1}{v_p^2} \frac{\partial^2 E_x}{\partial t^2} \quad (8.36)$$

where

$$v_p = \frac{1}{\sqrt{\varepsilon_0 \mu_0}} \quad (8.37)$$

is the velocity of light. Equation (8.36) is the wave equation which was first encountered in Equation (7.4).

If the electric field terms are eliminated from Equations (8.33) and (8.34) in a similar manner, the result is

$$\frac{\partial^2 H_y}{\partial z^2} = \frac{1}{v_p^2} \frac{\partial^2 H_y}{\partial t^2} \quad (8.38)$$

The two wave equations have the following general solutions for waves travelling in the positive z -direction:

$$E_x = E_0 \exp[j(\omega t - kz)] \quad (8.39)$$

and

$$H_y = H_0 \exp[j(\omega t - kz)] \quad (8.40)$$

where E_0 and H_0 are complex amplitudes which incorporate the relative phases of the electric and magnetic fields.

The relationship between the two fields can be found by substituting Equations (8.39) and (8.40) into either Equation (8.33) or Equation (8.44). Making use of Equation (8.33), we get

$$-jk E_0 \exp[j(\omega t - kz)] = -j\omega \mu_0 H_0 \exp[j(\omega t - kz)] \quad (8.41)$$

From this it can be seen that E_x and H_y are in phase with one another. Also that

$$\frac{E_0}{H_0} = \sqrt{\frac{\mu_0}{\varepsilon_0}} = 377 \Omega \quad (8.42)$$

We recognise this as the wave impedance of a wave in free space (see Equation (7.51)). It is sometimes referred to as the **intrinsic impedance of free space**.

Figure 8.3 illustrates the complete solution which has been obtained. It is necessary to be a little careful in interpreting this diagram. It shows the amplitudes of the field vectors rather than being a map of the field. The whole field pattern is moving in the z -direction with the velocity of light. At any instant the electric and magnetic field strengths are uniform at all points in a plane perpendicular to the z -axis.

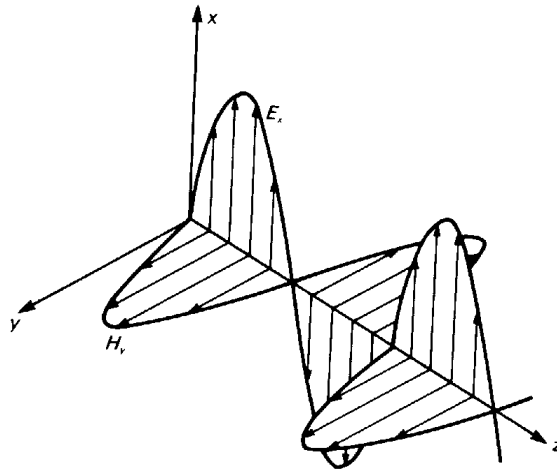

Fig. 8.3 The electric and magnetic fields in a plane electromagnetic wave propagating in the z -direction.

Struggling to get interviews?

Professional CV consulting & writing assistance from leading job experts in the UK.

Visit site

Take a short-cut to your next job!
Improve your interview success rate by 70%.

TheCVagency
Visit theagency.co.uk for more info.

Click on the ad to read more

8.7 Power flow in an electromagnetic wave

In Chapter 7 it was shown that the power flow in a coaxial line could be calculated correctly by assuming that the stored energy in the electromagnetic field travelled with the phase velocity in the direction of the wave. For waves in free space the energy density is, from Equation (7.54),

$$w = \epsilon_0 E_x^2 \quad (8.43)$$

The instantaneous power density in the wave is

$$S = w v_p = \frac{\epsilon_0 E_x^2}{\sqrt{\epsilon_0 \mu_0}} = E_x H_y \quad (8.44)$$

Now S is in the z -direction, so it is possible to write Equation (8.44) in vector notation as

$$\mathbf{S} = \mathbf{E} \wedge \mathbf{H} \quad (8.45)$$

The vector \mathbf{S} is known as the **Poynting vector**. Poynting's theorem states:

The integral of $(\mathbf{E} \wedge \mathbf{H})$ over a closed surface is equal to the instantaneous flow of electromagnetic power out of the volume enclosed by that surface.

The proof of this theorem is beyond the scope of this book. Note that, strictly speaking, it is the integral of \mathbf{S} over a closed surface which has meaning rather than \mathbf{S} itself. We have already seen that the integral of the Poynting vector gives the correct answer for the power flow in a lossless coaxial line.

8.9 Summary

We have considered how Maxwell removed an inconsistency in the magnetic circuit law by introducing the idea of the displacement current. The modified law was expressed in differential form by introducing the curl of the vector \mathbf{H} . Faraday's law was also put into differential form by using the curl of \mathbf{E} .

The mathematical statements of the laws of electromagnetism were collected together in both their integral and differential forms. This set of equations is known as Maxwell's equations. It was demonstrated that, for the special case of plane waves in free space, Maxwell's equations lead naturally to the prediction of the existence of electromagnetic waves which travel with the speed of light.

Finally, it was shown that the power flow in the electromagnetic field can be represented by the Poynting vector $(\mathbf{E} \wedge \mathbf{H})$.

9 Bibliography

Note

The books in this list should provide you with the means of obtaining further information on any part of the theory of electromagnetism discussed in this book. They should also provide a way into the professional literature dealing with the applications of electromagnetism. Some of the older books are now out of print; they have been included because of their lasting value or because no more recent books exist on those subjects.

Electromagnetism

Elementary

Bolton, B., *Electromagnetism and its Applications: an introduction*, Van Nostrand Reinhold (1980).
Compton, A.J., *Basic Electromagnetism and its Applications*, Van Nostrand Reinhold (1986).

Intermediate

Bleaney, B.I. and Bleaney, B., *Electricity and Magnetism* (3rd edn), Oxford University Press (1976).
Carter, R.G., *Electromagnetic Waves: Microwave Components and Devices*, Chapman and Hall (1990).
Carter, G.W., *The Electromagnetic Field in its Engineering Aspects* (2nd edn), Longman (1967).

Advanced

Ramo, S., Whinnery, J.R. and van Duzer, T., *Fields and Waves in Communication Electronics* (3rd Edn) Wiley (1994)

Solution of field problems

Binns, KJ. and Lawrenson, P.J., *Analysis and Computation of Electric and Magnetic Field Problems*, Pergamon (1963).
Silvester, P.P. and Ferrari, R.L., *Finite Elements for Electrical Engineers*. Cambridge University Press (1983).
Smythe, W.R., *Static and Dynamic Electricity*, McGraw-Hill (1939).

Energy methods

Hammond, P., *Energy Methods in Electromagnetism*, Oxford University Press (1981).

Applications of electromagnetism

Electrostatics

Bright, A.W., Corbett, R.P. and Hughes, J.F., *Electrostatics*, Oxford University Press (1978).
Moore, A.D. (ed.), *Electrostatics and its Applications*, Interscience (1973).

Magnetism

Parker, R.J. and Studders, R.J., *Permanent Magnets and their Applications*, Wiley (1962).

Wright, W. and McCaig, M., *Permanent Magnets*, Oxford University Press (1977).

Electric and magnetic devices

Bar-Lev, A., *Semiconductors and Electronic Devices* (2nd edn), Prentice Hall (1984).

Dummer, G.W.A. and Nordenberg, H.N., *Fixed and Variable Capacitors*, McGraw-Hill (1960).

Grossner, N.R., *Transformers for Electronic Circuits*, McGraw-Hill (1967).

Sangwine, S.J., *Electronic Components and Technology: Engineering Applications*, Van Nostrand Reinhold (UK) (1987).

Slemon, G.R., *Magneto-electric Devices*, Wiley (1966).

Spangenburg, K., *Vacuum Tubes*, McGraw-Hill (1948).

Electromagnetic interference

Freeman, E.R. and Sachs, H.M., *Electromagnetic Compatibility Design Guide*, Artech House (1982).

Keiser, B.E., *Principles of Electromagnetic Compatibility*, Artech House (1983).

Morrison, R., *Grounding and Shielding Techniques in Instrumentation*, Wiley (1977).

Walker, C.S., *Capacitance, Inductance and Crosstalk Analysis*, Artech House (1990).

gaiTEYE
Challenge the way we run

**EXPERIENCE THE POWER OF
FULL ENGAGEMENT...**

**RUN FASTER.
RUN LONGER..
RUN EASIER...**

**READ MORE & PRE-ORDER TODAY
WWW.GAITEYE.COM**

The advertisement features a background image of a person running on a path during a sunrise or sunset. The GaiTEYE logo is in the top left. The main text is in the center-left. A yellow button with a hand cursor icon is in the bottom right of the ad area.

Properties of materials

Dummer, G.W.A., *Materials for Conductive and Resistive Functions*, Hayden Book Co. (1970).

Heck, C., *Magnetic Materials and their Applications*, Butterworths (1974).

Sillars, R.W., *Electrical Insulating Materials and their Application*, Peter Peregrinus (1973).

General reference

Fink, D.G., Jurgen, R.K, Torrero, E.A. and Christiansen, D., *Electronic Engineers' Handbook* (4th edn), McGraw-Hill (1997).

Hughes, L.E.C. and Mazda, F. (ed.), *Electronic Engineer's Reference Book*, Butterworth-Heinemann (1992).

This e-book
is made with
SetaPDF



SETASIGN



PDF components for PHP developers

www.setasign.com



10 Appendix

Physical constants

Primary electric constant (ϵ_0)	8.854×10^{-12}	F m ⁻¹
Primary magnetic constant (μ_0)	$4\pi \times 10^{-7}$	H m ⁻¹
Velocity of light in vacuum	0.2998×10^9	m s ⁻¹
Wave impedance of free space	376.7	Ω
Charge on the electron	-1.602×10^{-19}	C
Rest mass of the electron	9.108×10^{-31}	kg
Charge/mass ratio of the electron	-1.759×10^{11}	C kg ⁻¹

Properties of dielectric materials

	Relative permittivity
Alumina 99.5%	10
Alumina 96%	9
Barium titanate	1200
Beryllia	6.6
Epoxy resin	3.5
Ferrites	13-16
Fused quartz	3.8
GaAs (high resistivity)	13
Nylon	3.1
Paraffin wax	2.25
Perspex	2.6
Polystyrene	2.54
Polystyrene foam	1.05
Polythene	2.25
PTFE (Teflon)	2.08

Properties of conductors

Conductivity (S m ⁻¹)	
Aluminium	3.5×10^7
Brass	1.1×10^7
Copper	5.7×10^7
Distilled water	2×10^{-4}
Ferrite (typical)	10^{-2}
Fresh water	10^{-3}

Gold	4.1×10^7
Iron	0.97×10^7
Nickel	1.28×10^7
Sea water	4
Silver	6.1×10^7
Steel	0.57×10^7

Properties of ferromagnetic materials

	μ_r	Saturation magnetism (B_{sat}) (T)
Ferroxcube 3	1500	0.2
Mild steel	2000	1.4
Mumetal	80 000	0.8
Nickel	600	
Silicon iron	7 000	1.3

Summary of vector formulae in Cartesian coordinates

$$\mathbf{a} = a_x \hat{\mathbf{x}} + a_y \hat{\mathbf{y}} + a_z \hat{\mathbf{z}}$$

$$\mathbf{a} \cdot \mathbf{b} = a_x b_x + a_y b_y + a_z b_z$$

$$\mathbf{a} \wedge \mathbf{b} = (a_y b_z - a_z b_y) \hat{\mathbf{x}} + (a_z b_x - a_x b_z) \hat{\mathbf{y}} + (a_x b_y - a_y b_x) \hat{\mathbf{z}}$$

$$\nabla = \frac{\partial}{\partial x} \hat{\mathbf{x}} + \frac{\partial}{\partial y} \hat{\mathbf{y}} + \frac{\partial}{\partial z} \hat{\mathbf{z}}$$

$$\text{grad } V = \nabla V = \frac{\partial V}{\partial x} \hat{\mathbf{x}} + \frac{\partial V}{\partial y} \hat{\mathbf{y}} + \frac{\partial V}{\partial z} \hat{\mathbf{z}}$$

$$\text{div } \mathbf{a} = \nabla \cdot \mathbf{a} = \frac{\partial a_x}{\partial x} + \frac{\partial a_y}{\partial y} + \frac{\partial a_z}{\partial z}$$

$$\text{curl } \mathbf{a} = \nabla \wedge \mathbf{a} = \left\{ \frac{\partial a_z}{\partial y} - \frac{\partial a_y}{\partial z} \right\} \hat{\mathbf{x}} + \left\{ \frac{\partial a_x}{\partial z} - \frac{\partial a_z}{\partial x} \right\} \hat{\mathbf{y}} + \left\{ \frac{\partial a_y}{\partial x} - \frac{\partial a_x}{\partial y} \right\} \hat{\mathbf{z}}$$

$$\nabla^2 V = \frac{\partial^2 V}{\partial x^2} + \frac{\partial^2 V}{\partial y^2} + \frac{\partial^2 V}{\partial z^2}$$

Summary of the principal formulae of electromagnetism

Inverse square law of electrostatic force

$$\mathbf{F} = \frac{Q_1 Q_2}{4\pi\epsilon_0 r^2} \hat{\mathbf{r}}$$

Relationship between \mathbf{E} and \mathbf{D}

$$\mathbf{D} = \epsilon \mathbf{E} = \epsilon_0 \epsilon_r \mathbf{E}$$

Gauss' theorem

$$\oiint \mathbf{D} \cdot d\mathbf{S} = \iiint \rho \, dv \qquad \operatorname{div} \mathbf{D} = \nabla \cdot \mathbf{D} = \rho$$

Electrostatic potential difference

$$V_B - V_A = - \int_A^B \mathbf{E} \cdot d\mathbf{l} \qquad \mathbf{E} = - \operatorname{grad} V = -\nabla V$$

Poisson's equation

$$\nabla^2 V = - \frac{\rho}{\epsilon_0}$$

Energy density in an electric field

$$w = \frac{1}{2} \mathbf{D} \cdot \mathbf{E}$$

Ohm's law

$$\mathbf{J} = \sigma \mathbf{E} \qquad \mathbf{E} = \rho \mathbf{J}$$

Power dissipated per unit volume

$$p = \mathbf{E} \cdot \mathbf{J}$$

Continuity equation

$$\oiint_S \mathbf{J} \cdot d\mathbf{A} = - \frac{\partial}{\partial t} \iiint_V \rho \, dv \qquad \nabla \cdot \mathbf{J} = - \frac{\partial \rho}{\partial t}$$

Electromotive force

$$\Rightarrow \oint \mathbf{E} \cdot d\mathbf{l}$$

Law of force between moving charges

$$\mathbf{F} = \frac{Q_1 Q_2}{4\pi\epsilon_0 r^2} \hat{\mathbf{r}} + \frac{\mu_0 Q_1 Q_2}{4\pi r^2} (\mathbf{v}_2 \wedge (\mathbf{v}_1 \wedge \hat{\mathbf{r}}))$$

Force on a moving charge

$$\mathbf{F} = Q(\mathbf{E} + (\mathbf{v} \wedge \mathbf{B}))$$

Force on a current-carrying conductor

$$\mathbf{F} = I(d\mathbf{l} \wedge \mathbf{B})$$

Biot-Savart law

$$\mathbf{B} = \frac{\mu_0 I}{4\pi} \oint \frac{d\mathbf{l} \wedge \hat{\mathbf{r}}}{r^2}$$

**YOU THINK.
YOU CAN WORK
AT RMB**

**RAND
MERCHANT
BANK**
A Division of FirstRand Bank Limited
Traditional values. Innovative ideas.

Rand Merchant Bank uses good business to create a better world, which is one of the reasons that the country's top talent chooses to work at RMB. For more information visit us at www.rmb.co.za

Thinking that can change your world

Rand Merchant Bank is an Authorised Financial Services Provider



Click on the ad to read more

Relationship between \mathbf{B} and \mathbf{H}

$$\mathbf{B} = \mu\mathbf{H} = \mu_0\mu_r\mathbf{H}$$

Magnetic circuit law as modified by Maxwell

$$\oint_C \mathbf{H} \cdot d\mathbf{l} = \iint_S \left(\mathbf{J} + \frac{d\mathbf{D}}{dt} \right) \cdot d\mathbf{A} \quad \text{curl } \mathbf{H} = \nabla \wedge \mathbf{H} = \mathbf{J} + \frac{\partial \mathbf{D}}{\partial t}$$

Conservation of magnetic flux

$$\oiint \mathbf{B} \cdot d\mathbf{A} = 0 \quad \text{div } \mathbf{B} = \nabla \cdot \mathbf{B} = 0$$

Faraday's law of induction

$$\oint \mathbf{E} \cdot d\mathbf{l} = -\iint \frac{\partial \mathbf{B}}{\partial t} \cdot d\mathbf{A} \quad \text{curl } \mathbf{E} = \nabla \wedge \mathbf{E} = -\frac{\partial \mathbf{B}}{\partial t}$$

Energy density in a magnetic field

$$w = \frac{1}{2} \mathbf{B} \cdot \mathbf{H}$$

The Poynting vector

$$\mathbf{S} = \mathbf{E} \wedge \mathbf{H}$$